



REPORT FOR INCOMPAS

# THE IMPACT OF TECH COMPANIES' NETWORK INVESTMENT ON THE ECONOMICS OF BROADBAND ISPs

David Abecassis, Michael Kende, Shahan Osman, Ryan Spence, Natalie Choi

OCTOBER 2022

A blue-toned cityscape at night with various digital icons like a Wi-Fi symbol, a shopping cart, and a cloud floating over the buildings, with vertical lines representing data connections.

[analysismason.com](https://www.analysismason.com)

## Disclaimer

This report was commissioned by INCOMPAS, the internet and competitive networks association (formerly COMPTTEL), a US-based industry trade association advocating for competition policy across all networks, and prepared independently by Analysys Mason.

We are grateful for the inputs and support provided by INCOMPAS, its members, and organizations which agreed to be interviewed as part of this study. Additional industry trade organizations involved in the distribution of the report include the Computer & Communications Industry Association (CCIA), the Asia Internet Coalition (AIC), DOT Europe, and the Korea Internet Corporations Association (K-Internet).

The analysis contained in this document is the sole responsibility of Analysys Mason and does not necessarily reflect the views of INCOMPAS, CCIA, AIC, DOT Europe, K-Internet, their members, or other contributors to the study. The data used in the analysis was obtained independently by Analysys Mason from publicly available sources.

Copyright © 2022. Analysys Mason has produced the information contained herein for INCOMPAS. The ownership, use and disclosure of this information are subject to the Commercial Terms contained in the contract between Analysys Mason and INCOMPAS.

Analysys Mason Limited  
North West Wing, Bush House  
Aldwych  
London WC2B 4PJ  
UK  
Tel: +44 (0)20 7395 9000  
london@analysysmason.com  
www.analysysmason.com  
Registered in England and  
Wales No. 5177472

# Contents

<b>Abstract</b>	<b>4</b>
<b>Executive summary</b>	<b>5</b>
<b>1 Introduction</b>	<b>11</b>
<b>2 Content and application providers invest over USD120 billion annually in internet infrastructure</b>	<b>16</b>
2.1 The internet is a network of networks that enables, and is reinforced by, a diverse ecosystem of stakeholders who interconnect with one another to create a fluid exchange of traffic	16
2.2 CAPs invest significant amounts in hosting, transport, and delivery networks	18
2.3 CAPs' investment in internet infrastructure has a positive impact on CAPs, ISPs, and the wider economy and society	27
<b>3 Investments by CAPs in transport and delivery networks save ISPs an estimated USD5.0–6.4 billion annually</b>	<b>30</b>
3.1 Demand for connectivity is intrinsically linked to demand for online services, with strong synergies recognized by CAPs and ISPs through marketing partnerships	30
3.2 Traffic volumes drive a relatively small share of costs for ISPs, and technological advancements in network technology lead to continuous reductions in unit costs	32
3.3 Investments made by CAPs in transport and delivery networks help ISPs to mitigate costs	36
<b>4 When evaluating network usage fees, policy makers should consider regulatory objectives holistically and scrutinize arguments made in favor of their implementation</b>	<b>44</b>
4.1 Calls for network usage fees have emerged in a few regions, and have largely focused on infrastructure deployment, while avoiding other topics such as competition	44
4.2 Mandated traffic-related fees could have a detrimental impact on stakeholders across the internet ecosystem, which should be concerning to regulators	46
4.3 Calls for the regulation of traffic-related fees paid by CAPs to ISPs are not well substantiated, and these fees are unlikely to deliver the envisioned benefits	53
<b>5 Implementing network usage fees could disrupt existing arrangements and reverse gains made in connectivity to date</b>	<b>58</b>
<b>Annex A</b> Background on interconnection on the internet and in traditional telecom services	60
<b>Annex B</b> Methodology for estimating CAP infrastructure investment, and examples of how investments are evolving	62
<b>Annex C</b> Context on the impact of traffic on fixed and mobile network costs and methodology for estimating traffic-sensitive costs for fixed networks	71
<b>Annex D</b> Research on FTTP network investment	80

## Abstract

This report is intended to bring a clear and evidence-based perspective to the global debate regarding whether network usage fees should be introduced. It explains the interdependence of various stakeholders in the internet ecosystem and the mutually beneficial arrangements that they currently enter into for internet interconnection. In particular, we consider the relationship between content and application providers (CAPs) which provide online services and content that end users and other stakeholders demand, and the internet service providers (ISPs) which provide residential and business end users with the means to connect to the internet from their homes, offices, and mobile devices. We examine the implications of mandating that CAPs pay ISPs network usage fees linked to traffic flows between their networks in order to reach ISPs' end users, and we conclude that such a mandate would be harmful to end users and the global internet ecosystem.

We first highlight the significant investments that CAPs make in global internet infrastructure (over and above their investments in content, innovation, research, and development). Contrary to the assertions that CAPs are not investing in internet network infrastructure, we find that in the last decade, CAPs invested USD883 billion in digital infrastructure. This builds upon analysis conducted since 2014, and we find that between 2018 and 2021, CAPs increased their annual spend by over 50% compared to the 2014 to 2017 period, investing over USD120 billion in digital infrastructure, including hosting, transport, and delivery networks. These investments not only support the delivery of CAPs' own services, but also support the ISPs' business.

The combination of investments by CAPs and ISPs as well as freely negotiated interconnection on the internet has evolved over time to support increased traffic demand from end users. Investments made by CAPs to bring traffic closer to end users improve quality of experience for broadband users and save ISPs over USD5 billion each year in network and transit fees. The voluntary agreements between CAPs and ISPs ensure that growing demand from end users can be handled sustainably without

increasing network costs over time. This framework ensures that ISPs do not shoulder all the cost of digital infrastructure, while enabling end users to gain access to diverse and high-quality online services.

We find that the imposition of network usage fees would risk creating barriers to entry and growth for smaller and new CAPs. In broadband markets, mandated network usage fees also risk increasing costs for many ISPs, by reducing CAPs' incentives to invest in infrastructure and processes that help optimize traffic delivery for ISPs, such as caching content closer to end users. Higher cost of traffic delivery for CAPs and higher network costs for ISPs may translate into lower quality of experience for end users. Higher costs for ISPs would heighten barriers to entry and growth for smaller and new ISPs, reducing long-term ISP competition and investment in broadband. Consequently, end users are likely to face higher ISP prices, less ISP choice, and reduced quality of broadband services, while also receiving diminished quality of experience for online services and less innovation and choice online.

Current proposals for mandating network usage fees rely on arguments that falter under scrutiny. Proponents of these fees tend to mischaracterize the relationship between traffic delivery and cost, while understating ongoing investments by CAPs in internet infrastructure, as well as private- and public-sector investments in ISP networks. Some arguments made in favor of network usage fees also appear to be based on an inadequate understanding of internet interconnection. If introduced, network usage fees would result in a shift away from the voluntary interconnection regime that continues to drive the rapid growth and impact of the internet. Policy makers should therefore scrutinize any network usage fee proposals carefully, while taking a holistic perspective on the potential harmful impact of those fees on the wider internet ecosystem.

## Executive summary

The internet is now more accessible than ever to more people around the world. The growth of the internet – and internet-enabled services and goods – has resulted in consumers, businesses, and governments conducting more daily activities online. The internet thus serves as the backbone for work, education, entertainment, and communication, and has proven to be essential, particularly during the Covid-19 lockdowns.

The internet is a network of networks, which must all be connected (directly or indirectly) to one another to enable traffic delivery from any source to any destination around the globe. Its evolution has been driven by a combination of competition, collaboration, and innovation by all the stakeholders in the value chain. These players include:

- Internet service providers (ISPs), which provide residential and business end users the means to connect to the internet from their homes, offices, and mobile devices.
- 'Tier 1' global carriers, which invest and operate large-scale transmission networks that move content around the world and connect together the many networks that make up the internet.
- A wide variety of other companies that provide technology, services, and content to end users and other stakeholders through internet access and are referred to as content and application providers (CAPs). This includes cloud providers which invest in and operate data centers, peering and caching infrastructure, and increasingly their own backbone networks around the world.

Some stakeholders, including large, vertically integrated ISPs, have argued that growing internet traffic creates a cost burden on ISPs, which they argue is unsustainable. A central part of the argument put forward by these stakeholders is the notion that CAPs are benefiting from the network without investing in network infrastructure. As such, they call for policy makers to mandate that CAPs pay ISPs network usage fees that would be based on the amount of traffic delivered to end users.

This report demonstrates that:

1. CAPs are investing significant amounts in internet infrastructure (above and beyond their investments in content and applications for end users), and these infrastructure investments increase over time, reaching nearly USD900 billion in total over the period 2011–21.
2. Network-related costs for ISPs have remained stable over time even while traffic volumes have grown significantly. Data traffic only drives a small share of ISP costs, which are further mitigated by the investments that CAPs make in internet infrastructure.
3. The arguments put forth by proponents of network usage fees disregard ongoing trends in access network investment, and demonstrate an inadequate understanding of internet interconnection.
4. If introduced, network usage fees would disrupt existing interconnection arrangements, as well as incentives for stakeholders in the ecosystem to continue investing to deliver a high quality of experience for end users.

Policy makers should consider the potential impact of network usage fees holistically when evaluating regulatory proposals that would mandate the introduction of such fees.

### **CAPs invest over USD120 billion annually in internet infrastructure**

Over the period 2011–21, CAPs spent USD883 billion on digital infrastructure including hosting, transport, and delivery networks, leading to positive impacts on end users, and broader economic benefits.

CAPs focus their internet infrastructure investments on three main clusters – hosting (i.e. data centers), transport (i.e. submarine and terrestrial cables), and delivery (i.e. peering and caching). This infrastructure spans tens of thousands of miles around the globe and is critical to deliver online content and services close to ISPs for the benefit of end users' online experience.

CAPs are investing heavily in hosting, transport, and delivery networks. In 2018–21, CAPs increased their annual investment by 50% over the previous period (2014–17) and spent on average USD120 billion each year on this infrastructure. As a result of the annual

investment amounts shown in the chart below over various periods, CAPs have spent a total of USD883 billion on infrastructure in these three main clusters from 2011 to 2021.

**FIGURE 0.1: AVERAGE ANNUAL INVESTMENT MADE BY CAPs**  
[SOURCE: ANALYSYS MASON BASED ON VARIOUS SOURCES, 2014,<sup>1</sup> 2018,<sup>2</sup> 2022]

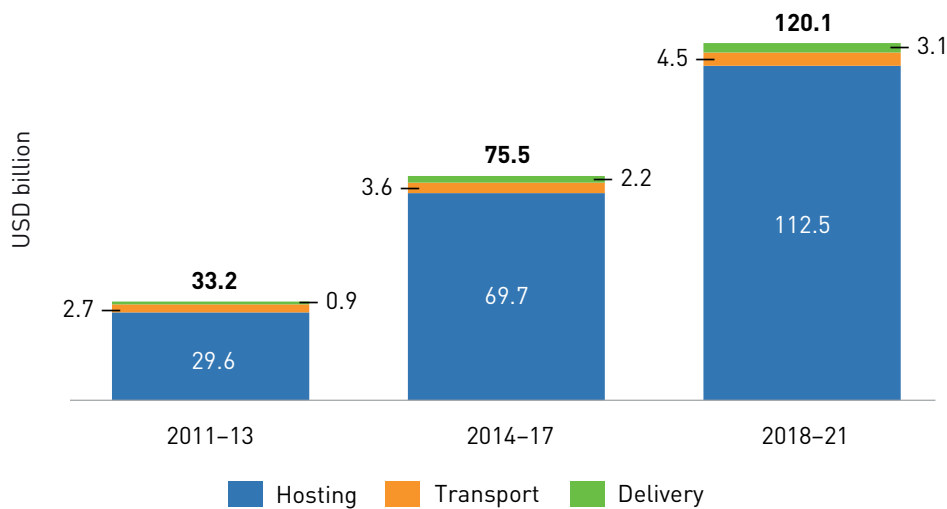

CAPs' investment in internet infrastructure increases reliability and quality of experience for end users. More broadly, we highlight the many studies that have shown how these investments drive overall internet penetration and usage and, as a result, generate macroeconomic benefits through digitalization. These include increased GDP, job creation, and environmental benefits, as well as better societal outcomes (e.g. education, health, access to remote work) from the consumption of online services.<sup>3</sup> Policy makers have also recognized the important role that the internet can play in unlocking these benefits.<sup>4</sup>

**Investments by CAPs in transport and delivery networks have a positive impact on the economics of ISPs**

As a result of scale, technology improvements, and investments across the value chain, strong growth in traffic has not led to materially increased costs for ISPs. Investments made by CAPs to bring traffic closer to end users improve quality of experience and save ISPs between ~USD5.0 billion and ~USD6.4 billion each year. Voluntary agreements between CAPs and ISPs ensure that growing demand from end users can be handled sustainably without increasing network costs over time.

CAP investments to bring content closer to ISPs and end users generate benefits for end users in terms of better quality of experience, but also benefit ISPs in terms

<sup>1</sup>Analysys Mason (2014), *Investment in networks, facilities and equipment by content and application providers*. Available at <https://www.analysismason.com/consulting-redirect/reports/content-application-provider-investment/>

<sup>2</sup>Analysys Mason (2018), *Infrastructure investment by online service providers*. Available at <https://www.analysismason.com/consulting-redirect/reports/online-service-providers-internet-infrastructure-dec2018/>

<sup>3</sup>Deloitte (2014), *Economic and social benefits of expanding internet access*. Available at <https://www2.deloitte.com/content/dam/Deloitte/uk/Documents/technology-media-telecommunications/deloitte-uk-tmt-value-of-connectivity-tmt.pdf>

<sup>4</sup>For example, see the digital targets for 2030 as set out by the European Commission, available at [https://ec.europa.eu/info/strategy/priorities-2019-2024/europe-fit-digital-age/europes-digital-decade-digital-targets-2030\\_en](https://ec.europa.eu/info/strategy/priorities-2019-2024/europe-fit-digital-age/europes-digital-decade-digital-targets-2030_en)

of cost avoidance or cost savings. For example, CAPs invest in large infrastructure projects like submarine cables, thus reducing the need for ISPs to invest in these systems. CAPs also use their global scale to deliver traffic broadly in internet exchange points (IXPs) and other peering locations across the world, reducing the need for ISPs to purchase transit or connect internationally to CAP 'home bases'. CAPs also invest in on-net caches that are embedded inside ISP networks, which reduces the backbone and backhaul capacity that ISPs require to deliver content to end users.

We quantify CAP investments that contribute to ISP savings in two areas: CAP investments in embedded caching in ISP networks (at core/metro/aggregation nodes), and long-distance transport and peering locations (both public and private), which contribute to the widespread availability of 'on-shore' peering in ISP home markets. We estimate that this enables ISPs to reduce capacity-related costs by between USD5.0 billion and USD6.4 billion each year, globally.

The central argument for network usage fees relies on two premises: that CAPs are responsible for large and growing traffic volumes, and that large growth in traffic drives much higher network costs.

CAPs deliver traffic to ISPs when end users demand such content, and as demand for online services grows so does the demand for faster and generally more expensive broadband services that ISPs sell. A small number of large CAPs and content delivery networks (CDNs) deliver a large share of traffic demanded by end users, in part because they are very successful with end users, and in part because of the cost and quality benefits for all CAPs, large and small, to use their services due to their widely distributed CDNs that bring traffic either close to or directly into ISPs' networks.

Importantly, our analysis shows that the rapid increase in global traffic<sup>5</sup> delivered over fixed and mobile access networks is correlated with a stable annual spend by telecom operators on their networks, as shown in the figure below.

**FIGURE 0.2:** GROWTH IN TRAFFIC DELIVERED OVER FIXED AND MOBILE ACCESS NETWORKS, AND EVOLUTION OF NETWORK-RELATED TELECOM OPERATOR COSTS FROM 2018 TO 2021  
[SOURCE: ANALYSYS MASON RESEARCH, ANALYSYS MASON, 2022]

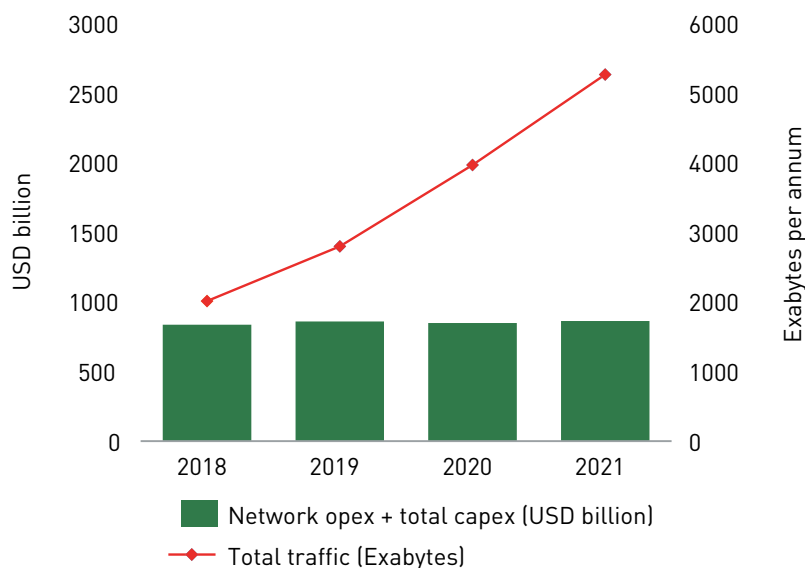

<sup>5</sup>Traffic refers to the flow of data through networks over time, and bandwidth determines the amount of traffic that can flow through at a given time. Networks are provisioned to provide a given bandwidth rather than a given level of traffic, and in many modern networks, capacity significantly exceeds bandwidth demand.

Moreover, we find that traffic volumes drive a relatively small share of ISPs' costs. ISPs are in the middle of a once-in-a-generation transition to fiber – investments are being made by the public and private sectors, which affect the topology/architecture of their networks, and therefore the magnitude of network costs and their sensitivity to traffic. As ISPs increasingly transition to fiber and achieve more efficient architectures through more advanced technology and equipment, their costs are expected to become even less sensitive to traffic in future.

Thus, network costs are expected to continue to remain relatively stable in the future while traffic volumes grow, as fixed networks move toward fiber-based architectures, and as mobile technologies evolve to enable operators to add network capacity more efficiently, further demonstrating the unreasonableness of any permanent transfer of mandated payments from CAPs to ISPs.

#### **Policy makers should consider regulatory objectives holistically and scrutinize arguments in favor of network usage fees**

Network usage fees would lead to regulatory and competition issues that policy makers already understand well: they have rejected network usage fees for the internet in the past, and have worked to mitigate similar issues in telephony markets for the last 20 years.

Proposals largely call for fees to be transferred from CAPs to ISPs on the basis of traffic for internet interconnection, one argument being that this mirrors voice termination rates in the telephony market. These mechanisms have worked for voice services as it is easy to identify the party that originated the call. For internet traffic, however, it is usually difficult to identify the originator of a stream of traffic, not least because CAPs send traffic in response to an end-user request. There also would be the challenge of deciding what the rate should be, where it is imposed, which entities are charged, how to reconcile these charges with non-discrimination and net-neutrality policies, and how to limit ISPs' ability to exercise their termination

monopoly. These challenges could result in excessive rates, leading to further regulation of quality of service, in addition to higher costs for end users. Some of these concerns have been raised in the past, for instance, when European regulators rejected similar proposals to regulate interconnection that emerged a decade ago.<sup>6</sup>

Proponents of network usage fees suggest that ISPs would invest more in connectivity and accelerate broadband deployment if they were able to charge CAPs for traffic. However, these arguments appear to disregard the large ongoing commitments made by ISPs themselves and by policy makers and other investors to roll out full-fiber networks throughout Europe, achieve 'Internet for All' in the US, and via other initiatives that are already underway for deploying broadband networks around the globe to unserved and underserved areas. Moreover, current proposals have not elaborated on mechanisms for ensuring ISPs use such fees on network investments that help to improve connectivity and end-user experience.

In this context, it seems unlikely that network usage fees would result in ISPs investing any more in networks. Instead, already large and vertically integrated ISPs would likely enjoy higher profits and shareholder returns at the expense of end users, who would face higher prices and a lower quality of experience.

#### **Implementing network usage fees could disrupt existing interconnection arrangements and investment dynamics, and reverse gains made in connectivity to date**

Beyond the lack of justification for network usage fees, policy makers should also consider the impact of network usage fees on the whole internet ecosystem. Network usage fees would effectively slow or reverse some of the advances in interconnection, peering, and caching that have evolved through voluntary, mutually beneficial arrangements that have aided ISPs and end users by lowering their costs and improving their service experience, respectively.

<sup>6</sup>BEREC (2012), *BEREC's comments on the ETNO proposal for ITU/WCIT or similar initiatives along these lines*. Available at [https://www.berec.europa.eu/sites/default/files/files/document\\_register\\_store/2012/11/BoR%2812%29120rev.1\\_BEREC\\_Statement\\_on\\_ITR\\_2012.11.14.pdf](https://www.berec.europa.eu/sites/default/files/files/document_register_store/2012/11/BoR%2812%29120rev.1_BEREC_Statement_on_ITR_2012.11.14.pdf)



The introduction of network usage fees would disrupt existing interconnection arrangements. This is likely to affect incentives for both CAPs and ISPs to continue making investments that deliver ongoing improvements in quality of experience for end users. Network usage fees would raise costs for all CAPs, not just larger ones, resulting in barriers to entry and expansion for online content and service providers.

Reduced incentives for CAPs to continue investing in infrastructure and processes that optimize traffic delivery will result in higher costs for ISPs as well, constraining resources for organic investment in ISP networks. Moreover, fees proportional to traffic paid directly to ISPs would favor larger ISPs, which may distort competition in the ISP market. As a result of these effects, end users are likely to face higher prices, reduced quality, and less choice in the ISP market, while also receiving a lower quality of experience for online services.

South Korea is currently the only country where the regulator have mandated payments from domestic CAPs and ISPs. The added costs imposed by network usage fees have led to higher transit costs, diverging from other countries in the region. As a result, Korean CAPs have found it challenging to host content domestically due to higher costs and have either moved overseas or have become less competitive.<sup>7</sup> Likewise, service quality is affected as the overall average latency experienced by users in South Korea is the highest among Organization for Economic Co-operation and Development countries.<sup>8</sup> Importantly, the introduction of network usage fees elsewhere could disincentivize CAPs or CDNs from deploying caches domestically in those other countries as well, leading to similar negative effects as those seen in South Korea.

Demand for online services and demand for broadband access are inherently linked. The impact of introducing network usage fees, and the resulting impact on end users, could be long lasting and harmful for both markets. Lower consumption of online services by individuals and businesses could also result in further negative effects in terms of slower digitalization and economic growth.

## Conclusion

Based on current proposals, network usage fees are unlikely to be beneficial to end users. These proposals are supported by arguments that mischaracterize the relationship between traffic delivery and cost, and that appear to be based on an inadequate understanding of internet interconnection. If implemented, network usage fees would result in a fundamental shift away from the voluntary collaboration that has sustained the rapid growth of the internet thus far, and negatively affect a wide range of stakeholders. Policy makers and regulators should scrutinize any proposal on network usage fees and take a holistic perspective on the potential harmful impact of those fees on the internet ecosystem.

<sup>7</sup> See <https://carnegieendowment.org/2021/08/17/afterword-korea-s-challenge-to-standard-internet-interconnection-model-pub-85166>

<sup>8</sup> OECD (2022), *Broadband networks of the future*. Available at <https://www.oecd-ilibrary.org/docserver/755e2d0c-en.pdf?expires=1659966485&id=id&accname=guest&checksum=85B0F3FB66FF03752FF411E10BF8E51>

# Mandated network usage fees could degrade network quality, decrease competition, and harm consumers

## Content and application providers (CAPs) invest extensively in global internet network infrastructure

Infrastructure investments in hosting, transport, and delivery are made in addition to other CAP investments in content, applications, and services for end users; the availability of these online services also drives demand for broadband access services from internet service providers (ISPs).

Total spend by CAPs on internet infrastructure over various periods since 2011

CAP investment in 2011–21 was USD883 billion. In the past four years (2018–21), CAPs invested USD120 billion per annum.

These investments help to reduce ISPs' costs, while optimizing performance for end users.

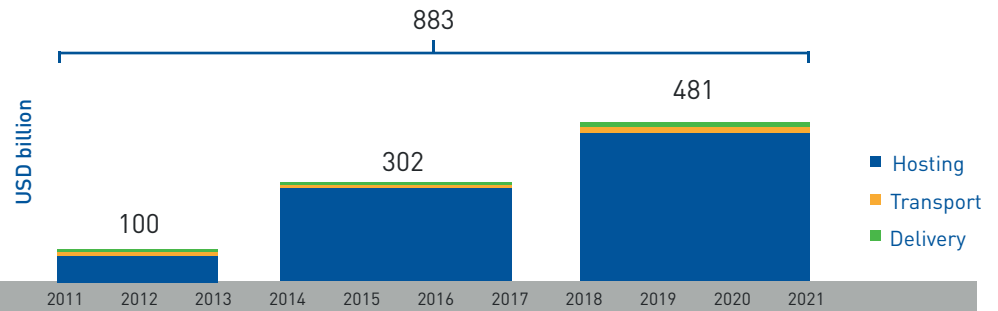

## The current voluntary interconnection regime incentivizes CAPs and ISPs to invest in efficient, cost-effective traffic delivery to provide quality experiences for end users

Growth in traffic delivered over fixed and mobile access networks, and evolution of network-related telecom operator costs from 2018 to 2021

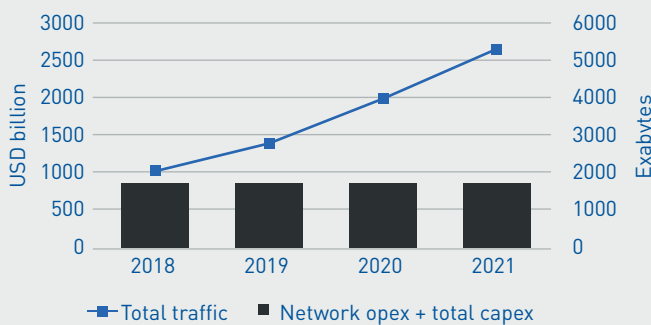

In 2018–21, network-related ISP costs increased by 3% in total over three years, whilst network traffic increased by over 160% in that same period, showing that ISP networks can handle significant traffic growth at modest incremental cost.

CAP network investments that bring content closer to end users also help ISPs to manage costs, saving ISPs USD5.0–6.4 billion per annum.

## Network usage fees would impose high interconnection costs for a non-existent problem, and they would disrupt incentives, investment, and competition

If introduced, network usage fees could have detrimental effects on multiple stakeholder types

### Impacts on CAPs include:

Fewer resources to invest in content and infrastructure

Higher barrier to entry for smaller/local CAPs

### Impacts on ISPs include:

Reduced ability to offer high-quality online experiences

Reduced long-term ISP competition and investment

### Impacts on end users (consumers and businesses) include:

Higher ISP prices, less ISP choice, and reduced quality of broadband services (e.g. latency)

Reduced quality of service from CAPs and fewer new CAPs to choose from in the future



# 1 Introduction

## Highlights

CAP investments in infrastructure are crucial for making traffic delivery more efficient for ISPs. This contributes significantly to end users' online experience (e.g. by reducing congestion or lowering latency), and also helps ISPs to manage their own network costs.

After three decades of accelerating growth and constant change, the internet continues to grow and evolve, most visibly in terms of the services and content that are accessible online, but also in terms of its technical architecture. Changes to the fabric of the internet, from protocol standards and interconnection agreements to hard infrastructure like fiber and wireless networks, submarine cables, and data centers, are driven by a combination of competition, collaboration, and innovation by all the stakeholders in the value chain.

These stakeholders include internet service providers (ISPs) that provide residential and business end users with the means to connect to the internet from their homes, offices, or mobile devices; so-called Tier 1 global carriers, which invest and operate large-scale transmission networks that move content around the world, and connect together the many networks that make up the internet; and also a wide variety of other companies that provide technology, services, and content to end users and other stakeholders. These providers include content delivery networks (CDNs) and

cloud providers, which invest in and operate data centers, peering and caching infrastructure, and increasingly their own backbone networks around the world. We refer to these as content and application providers (CAPs), and they are sometimes also referred to as online service providers (OSPs) or edge providers.

To date, the internet as we know it has been able to grow and thrive through mutually beneficial co-operation between these stakeholders, largely enabled by voluntary interconnection arrangements that have enabled a thriving and competitive peering market.<sup>9</sup> As shown in Figure 1.1, while internet traffic continues to grow annually as more users gain access to the internet, and users spend more time online on increasingly bandwidth-intensive content, the rate of traffic growth is declining each year for both fixed and mobile.<sup>10</sup> Moreover, due to advancements in network technology and equipment, unit costs of traffic delivery have historically decreased at rates that matched or exceeded increases in traffic per user.<sup>11</sup> The majority of internet traffic is delivered over fixed access networks as opposed to mobile access networks, and the rate of traffic growth is faster in emerging markets and slower in more mature markets. It is worth noting that while traffic is easier to measure, bandwidth is usually a more accurate determinant of whether networks are constrained or not, and at present, actual peak traffic on broadband networks remains significantly below the theoretical speed and capacity of access networks.<sup>12</sup>

<sup>9</sup> Analysys Mason (2020), *IP interconnection on the internet: a white paper*. Available at <https://www.analysismason.com/consulting-redirect/reports/ip-interconnection-korea-white-paper/>

<sup>10</sup> The change in growth rate from 2018–19 to 2019–20 was an exception to this trend, due to Covid-19.

<sup>11</sup> WIK-Consult (2014), *The economic impact of internet traffic growth on network operators*. Available at [https://www.wik.org/uploads/media/Google\\_Two-Sided\\_Mkts.pdf](https://www.wik.org/uploads/media/Google_Two-Sided_Mkts.pdf)

<sup>12</sup> Described further in another report published by Analysys Mason. See <https://www.analysismason.com/consulting-redirect/reports/netflix-open-connect/>

**FIGURE 1.1:** GROWTH IN END-USER DEMAND FOR TRAFFIC DELIVERED OVER FIXED AND MOBILE ACCESS NETWORKS<sup>13</sup>  
 [SOURCE: ANALYSYS MASON RESEARCH<sup>14,15</sup>]

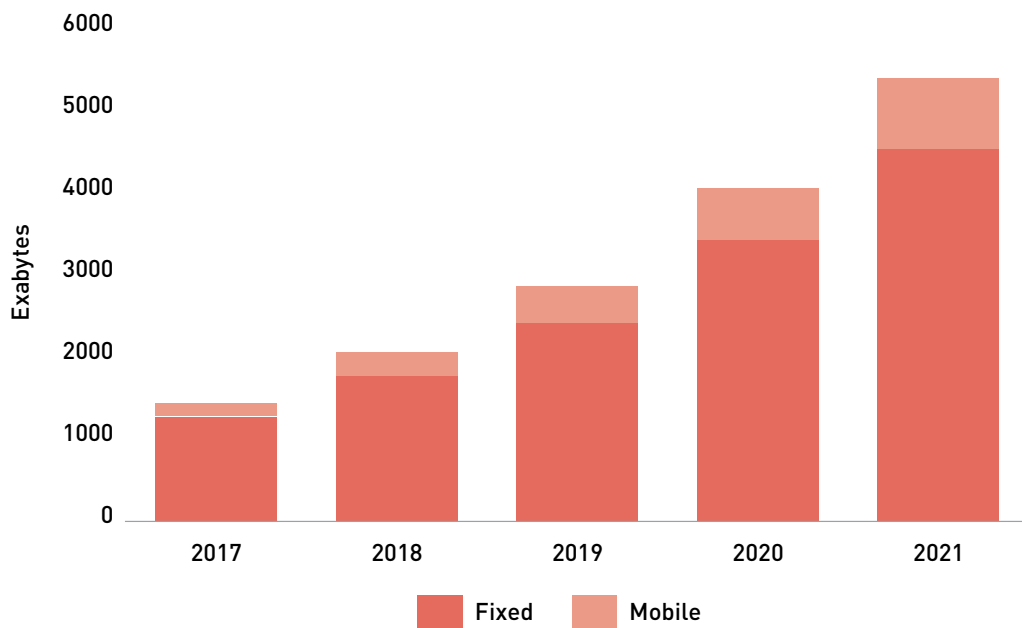

As the internet evolves, so does the growth of bandwidth-intensive content and applications including video and gaming. New applications such as virtual reality that can be used for online education, telemedicine, industrial activities, workplace use and training, tourism, and many other use cases, could

emerge to deliver new and improved online experiences for end users. Undoubtedly, as fiber and 5G networks become ubiquitous, use cases that we cannot anticipate today will emerge to take advantage of greater speeds and capacity in networks (see Figure 1.2).<sup>16</sup>

**FIGURE 1.2:** ILLUSTRATIVE REQUIREMENT FOR A RANGE OF APPLICATIONS, IN MBIT/S  
 [SOURCE: ANALYSYS MASON BASED ON CISCO ANNUAL INTERNET REPORT WHITE PAPER (2018-2023)]

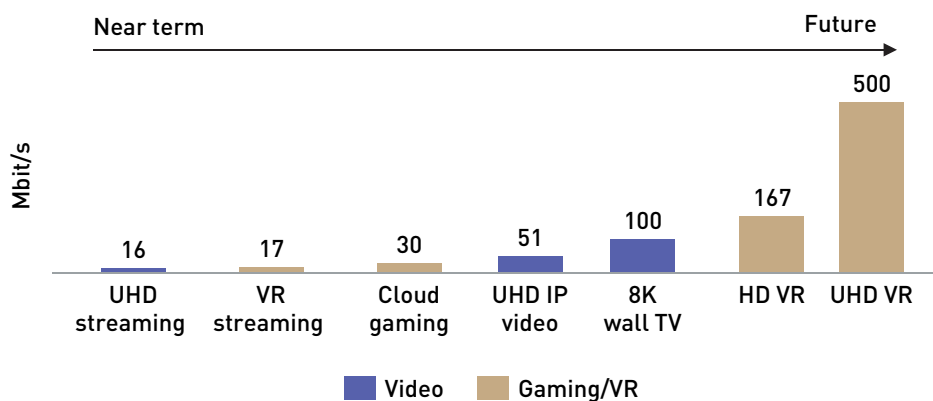

<sup>13</sup> Defined by Analysys Mason Research as total annual internet data for fixed access and total cellular data traffic for mobile access.

<sup>14</sup> Analysys Mason Research (2021), *Wireless network data traffic: worldwide trends and forecasts 2021-2026*. Available at <https://www.analysismason.com/research/content/regional-forecasts-/wireless-traffic-forecast-rdnt0/>

<sup>15</sup> Analysys Mason Research (2021), *Fixed network data traffic: worldwide trends and forecasts 2020-2026*. Available at <https://www.analysismason.com/research/content/regional-forecasts-/fixed-network-data-rdfi0-rdmb0/>

<sup>16</sup> Cisco (2020), *Cisco Annual Internet Report (2018-2023) White Paper*. Available at <https://www.cisco.com/c/en/us/solutions/collateral/executive-perspectives/annual-internet-report/white-paper-c11-741490.pdf>

In response to the growth in end-user demand for online content and applications, particularly during the Covid-19 pandemic, some stakeholders have raised concerns about whether this continued expansion will be sustainable or may place an unreasonable cost burden on some parts of the value chain, in particular ISPs. Policy makers also are concerned with ensuring that state-of-the-art connectivity can reach remote or underserved communities, where there may not be an attractive business case for investors to deploy next-generation broadband infrastructure. However, the Covid-19 pandemic has demonstrated the ability of the network to handle increases in traffic, and recent data shows that internet traffic growth has continued to decline following the spike in traffic growth during the pandemic.<sup>17</sup>

As a result, a number of recent policy initiatives have been launched to promote broadband infrastructure deployment and increased consumer connectivity, to ensure that access to and benefits of the internet are widespread and sustainable. These initiatives include, for example, setting clear objectives and timelines for fiber network deployments, implementing public financing mechanisms to support network deployment in unserved or underserved areas, subsidizing costs for disadvantaged consumers, requiring wholesale/open access to infrastructure to enable further deployment and competitive choice, and including coverage obligations for radio spectrum licenses.

Some stakeholders, primarily large, vertically integrated ISPs active in domestic infrastructure and internet access provision, but also in transit and carriage on the internet backbone, argue both that the

cost burden they shoulder due to growing traffic from a few CAPs is unsustainable, and that CAPs should contribute not only to those 'traffic-sensitive' costs, but also to the roll-out of infrastructure including fiber to the home and 5G networks.<sup>18</sup> This has led to calls for CAPs to pay network usage fees to ISPs, dependent on the amount of traffic end users request, to help pay for ISPs' networks. These calls have been heard across various regions, including South Korea,<sup>19</sup> Europe,<sup>20</sup> and the US.<sup>21, 22, 23</sup>

Smaller telecom operators, meanwhile, including European mobile virtual network operators (MVNOs), have pointed out that suggested network investment contributions could disrupt peering and transit markets that are currently functioning well, have detrimental effects on competition in telecom markets, and also negatively affect end users.<sup>24</sup>

In some ways, the argument for network usage fees would be similar to asserting that car manufacturers should pay for road construction and maintenance or, as others have pointed out, that electricity providers should receive a share of the value added in all sectors of the economy that use electricity (such as the profits of an electric vehicle manufacturer), even though consumers are already paying for the electricity they demand.<sup>25</sup>

It could also be said that these analogies understate the position taken by proponents of network usage fees as they fail to acknowledge the contributions that CAPs are already making, both within their own networks and in partnership with ISPs, to reduce the burden on local ISP networks and to improve quality of experience

<sup>17</sup> TeleGeography (2021), *Global internet traffic and capacity return to regularly scheduled programming*. Available at <https://blog.telegeography.com/internet-traffic-and-capacity-return-to-their-regularly-scheduled-programming>

<sup>18</sup> Some of the arguments revolve around the notion that CAPs are responsible for paying for ISPs' infrastructure, and/or capturing an excessive share of the value created on the internet at the expense of ISPs.

<sup>19</sup> Wik Consult (2022), *Competitive conditions on transit and peering markets*. Available at: [https://www.bundesnetzagentur.de/EN/Areas/Telecommunications/Companies/Digitisation/Peering/download.pdf?\\_\\_blob=publicationFile&v=1](https://www.bundesnetzagentur.de/EN/Areas/Telecommunications/Companies/Digitisation/Peering/download.pdf?__blob=publicationFile&v=1)

<sup>20</sup> Axon Partners Group (2022), *Europe's internet ecosystem: socio-economic benefits of a fairer balance between tech giants and telecom operators*. Available at <https://etno.eu/downloads/reports/europes%20internet%20ecosystem.%20socio-economic%20benefits%20of%20a%20fairer%20balance%20between%20tech%20giants%20and%20telecom%20operators%20by%20axon%20for%20etno.pdf>

<sup>21</sup> Forbes (2022), *The growing global movement for fair cost recovery on broadband networks*. Available at <https://www.forbes.com/sites/roslynlayton/2022/05/12/the-growing-global-movement-for-fair-cost-recovery-on-broadband-networks/?sh=12ef33c527a2>

<sup>22</sup> Newsweek (2022), *FCC Commissioner Brendan Carr Opinion: Ending big tech's free ride*. Available at <https://www.newsweek.com/ending-big-techs-free-ride-opinion-1593696>

<sup>23</sup> In addition, in the US some are calling for CAPs to pay directly into the Universal Service Fund, although CAPs currently pay USF charges when purchasing interstate telecom service in the provision of their CAP service in the US. See USTelecom Blog (2022), *25 years later, it's time for a FAIR Update to Universal Service*. Available at <https://ustelecom.org/25-years-later-its-time-for-a-fair-update-to-universal-service/>

<sup>24</sup> TechRadar (2022), *MVNOs fear they will be collateral damage of EU plans to make big tech pay for networks*. Available at <https://www.techradar.com/news/mvnos-fear-they-will-be-collateral-damage-of-eu-plans-to-make-big-tech-pay-for-networks>

<sup>25</sup> Williamson, B., *Communication Chambers (2022), An internet traffic tax would harm Europe's digital transformation*. Available at <http://www.comcham.com/traffic>

for end users. In fact, CAPs invest significantly in infrastructure, including data centers, submarine and terrestrial networks, and peering and caching infrastructure in nearly every country in the world, and increasingly within countries to bring content closer to ISPs. As a result, ISPs benefit from CAPs' investments to reliably deliver their service to end users and to provide a quality online experience.

The investments that CAPs make in infrastructure are in addition to their investments in the development of online services (content and applications) that end users enjoy. These online services are a clear driver of the demand for ISPs' own profitable connectivity services, including faster, fiber- or 5G-based connectivity.<sup>26</sup> Although end users might more readily associate the investments that CAPs make in content and applications with their quality of experience of those online services, CAP investments in infrastructure are in fact crucial for making traffic delivery more efficient for ISPs, which contributes significantly to end users' online experience (e.g. by reducing congestion or lowering latency), and also helps ISPs to manage their own network costs. As such, infrastructure investments by CAPs contribute significantly to supporting end-user demand for both the online services provided by CAPs, as well as the connectivity services provided by ISPs.

The potential impact of network usage fees on the broader internet ecosystem cannot be ignored, and has been considered in the past. European regulators have rejected previous attempts by telecom operators to move from the voluntary interconnection regime to a sending-party-network-pays model, in which CAPs would essentially pay network usage fees to ISPs. Regulators argued that moving to this payment model would be a dramatic change, and that benefits delivered by the voluntary interconnection regime, including innovation, growth in connectivity, and development of new content and applications, could be put at risk.<sup>27</sup> While internet traffic has increased significantly in the past decade, the voluntary interconnection regime remains a fundamental building block for maintaining a global and interoperable internet, based on co-operation between stakeholders operating within a competitive environment.

In this report, we aim to bring perspective to this debate and contribute to evidence-based policy making to ensure that digital infrastructure continues to attract investment, is deployed to all communities, and also preserves what has made a success of the internet over the last 30 years. We approach this in three main steps:

- In Section 2, we explain how the internet has evolved on the basis of collaboration between different stakeholders, how CAPs continue to invest in internet infrastructure and how they have continued to contribute to the growth of its economic and social impact. We also quantify the scale of investment in infrastructure by CAPs around the world and regionally, demonstrating their significant contribution to the global network ecosystem
  - specifically, we find that from 2018 to 2021, CAPs increased their investment to a total of USD120 billion annually; since 2011, CAPs have invested USD883 billion into internet infrastructure that ISPs and end users rely on for a quality internet experience.
- In Section 3, we explore how ISPs' costs respond to increasing data traffic and quantify how investments from CAPs in hosting, transport, and delivery network infrastructure are helping ISPs mitigate this cost impact through their own investment, and through commercially negotiated, and differentiated, partnerships with ISPs
  - specifically, we find that traffic volumes drive a relatively small share of ISPs' costs
  - in fixed ISP networks, traffic-sensitive core and backhaul costs are just ~20% of all network costs, or ~10% of retail revenue
  - growth in costs is also not proportional to growth in traffic volumes, as ISP costs and investment in their access networks have also remained relatively stable, even as traffic volumes have grown significantly
  - we also find that CAPs bring traffic closer to end users (and ISPs), generating between ~USD5.0 billion and ~USD6.4 billion in annual savings for ISPs.

<sup>26</sup> End users typically purchase connectivity services from ISPs in order to access the online services provided by CAPs.

<sup>27</sup> BEREC (2012), *BEREC's comments on the ETNO proposal for ITU/WCIT or similar initiatives along these lines*. Available at [https://www.berec.europa.eu/sites/default/files/files/document\\_register\\_store/2012/11/BoR%2812%29120rev.1\\_BEREC\\_Statement\\_on\\_ITR\\_2012.11.14.pdf](https://www.berec.europa.eu/sites/default/files/files/document_register_store/2012/11/BoR%2812%29120rev.1_BEREC_Statement_on_ITR_2012.11.14.pdf)

- In Section 4, we summarize and evaluate proposals currently in the public domain that are in favor of network usage fees, bring in additional perspectives, and describe the potential impact of network usage fees beyond ISPs' profits and returns (which has been the focus so far)
  - we find that network usage fees, if implemented, are likely to be detrimental for nearly all stakeholders in the internet ecosystem, and would result in reduced competition and higher costs, contrary to regulators' and policy makers' objectives.

A final conclusion section (Section 5) then ties findings from the rest of the report together to conclude that the assertions made in favor of network usage fees thus far are not well substantiated and could result in detrimental effects for interconnection, and the broader internet ecosystem and its future prospects.

## 2 Content and application providers invest over USD120 billion annually in internet infrastructure

The internet is made up of many interconnected networks that facilitate the exchange of traffic. This enables end users to communicate and gain access to content and applications from CAPs. The exchange of traffic is based on voluntarily negotiated agreements between these stakeholders, on the basis of a pervasive collaborative ethos. Section 2.1 describes the interconnection agreements that are necessary for the internet to function, and explains how the evolution of voluntary interconnection arrangements has contributed to the growth of the internet.

In order to deliver their content and applications to meet end-user demand, CAPs invest significant amounts in hosting, transport, and delivery networks, as discussed in Section 2.2. These investments have enabled end users to gain access to more content and services in an increasingly efficient manner. CAPs have continued to increase their investment, and we estimate that on average over the four years between 2018 and 2021, this investment exceeded USD120 billion annually. Based on our discussions and research, this trend appears to be continuing, fueling increased adoption, engagement, and usage of online services, including cloud services.

Investments made by CAPs primarily help to improve their service delivery, and the quality of experience that end users enjoy. These investments by CAPs complement investments made by other stakeholders, such as ISPs, to enable the functioning of the internet as we know it. There is growing empirical evidence that the internet infrastructure built and maintained by all stakeholders, including CAPs, generates wider benefits for society. These effects are introduced and discussed in Section 2.3.

### 2.1 The internet is a network of networks that enables, and is reinforced by, a diverse ecosystem of stakeholders who interconnect with one another to create a fluid exchange of traffic

#### Highlights

The networks that make up the internet must all be connected to one another in some way to enable traffic to be delivered from any source to any destination.<sup>28</sup>

Interconnection arrangements are mutually beneficial: a content provider can deliver its content to customers who request it, with largely the same cost and quality irrespective of the ISP chosen by the end user; this ISP, in turn, is able to offer high-quality access to content to its subscribers.

The agreements under which traffic is exchanged between networks emerged in the 1990s, as the internet began to commercialize and develop from its early roots in academia and research. The internet used the same telecom infrastructure used for voice calls at the time. However, while voice interconnection agreements were then heavily regulated, internet interconnection was commercially negotiated, and not regulated.

While internet interconnection arrangements have evolved from a small number of networks in the early days of commercialization to address globalization and the emergence of new high-bandwidth content, as well as new services and business models, they are still based on voluntary, commercial negotiations. Proposals to introduce interconnection regulations today that would require CAPs to pay ISPs are not necessary and will have impacts on all stakeholders, affecting the underlying success factors of the internet and adversely impacting consumer welfare.

#### 2.1.1 Interconnection agreements are needed for the internet to function, and are typically negotiated voluntarily between stakeholders

Interconnection arrangements are needed to solve a basic engineering challenge – how to exchange traffic between any two networks within a very large universe of autonomous systems that may not have a direct relationship, in the most efficient way possible, with a sufficient degree of resilience.<sup>29</sup>

The basic forms of interconnection which emerged are known as **peering** and **transit** – each plays a necessary role, and together they are sufficient to meet the ever-changing needs of the global internet (see Annex A for more details). Interconnection is critical for ISPs that are selling to end users the ability to

<sup>28</sup> This is often called the 'any-to-any' principle. There are currently more than 100 000 unique autonomous networks with their own autonomous system number (ASN) that enable them to share routing information for interconnecting and exchanging traffic.

<sup>29</sup> Resilience was one of the core objectives of the very early developments of the internet, under the auspices of the United States Defense Advanced Research Projects Agency (DARPA).



connect to 100 000 other unique autonomous networks around the world, and to the online content and applications these networks host.<sup>30</sup>

In the early days, the interconnection arrangements primarily relied on a hierarchy of internet providers. At the top of the hierarchy were backbones that had national or international network infrastructure. They exchanged traffic using **peering**, whereby two providers agree to exchange their own traffic (including that of their customers) with one another, using best efforts, i.e. with no guarantee of quality. Peering was between 'peers', that is to say, providers with similar networks and traffic profiles, and was almost exclusively without payment (this was also known as settlement-free peering).

The backbones at the top of the hierarchy, in turn, sold **transit** to smaller providers further down the hierarchy, including smaller backbones, retail ISPs, and CAPs. These transit arrangements enabled the buyers to access the whole of the internet. Peering was the wholesale input that enabled backbones to sell transit. The earliest content was largely text based and not real time, and thus competition in transit was largely based on price, which was kept affordable through settlement-free peering, and not based on quality, which could not be guaranteed in any case given that transit is based on best-efforts peering as an input.

As the internet has grown and services have changed, there have been several significant shifts in interconnection arrangements – all within the framework of commercially negotiated voluntary agreements. The first of these is the rise of interconnection hubs, including internet exchange points (IXPs), where many networks can exchange traffic in a cost-efficient manner with many other peers, facilitated by increased international capacity through more submarine and terrestrial routes. These served to flatten the hierarchy, by enabling Tier 2 ISPs and CAPs to invest or lease capacity to extend their network to other countries and to directly peer with global networks, without relying on transit. The second, described in the next sub-section, involves changes in the volume of traffic and the introduction of new

business models that extended the relationships between ISPs and CAPs.

### 2.1.2 Co-operation between CAPs and ISPs has evolved over time, and has supported the increasingly efficient delivery of traffic to end users at scale

Interconnection agreements have evolved over time, due to, for example, the increase in demand for high-bandwidth content such as video and gaming. This increase raised two issues with traffic exchange and delivery. First, the cost of delivering bandwidth-intensive content was a concern, as backbones and ISPs objected to receiving more traffic from content providers than they sent, at a higher cost of network capacity. And second, the quality of delivery became a greater concern as more delay-sensitive services (e.g. video calling, gaming, and some forms of streaming) became mainstream and CAPs' business models became more sensitive to the quality of experience delivered to end users.

Transit relationships are not conducive to addressing these concerns: transit providers offer access to the whole internet, and offer a largely undifferentiated connectivity product that is not managed for specific quality indicators like latency. Peering offers more help to mitigate these concerns and can be complemented by caching static content<sup>31</sup> in distributed servers that can serve content to end users when requested. In this way, content only needs to be sent once to the cache, instead of separately each time the content is requested, lowering the cost and reducing any possible congestion from delivering the content repeatedly over that part of the network.<sup>32</sup> CDNs have emerged as a technical solution that combines peering and caching, and are operated in house by the largest CAPs and as commercial services by companies such as Akamai, Cloudflare, as well as Google and Amazon through their cloud platforms (Google Cloud and AWS).

Peering and caching, including through commercial CDNs, have led to a distribution of interconnection and traffic delivery to many more locations, at scale. This now enables CAPs and ISPs to manage their costs and

<sup>30</sup> As we explain further below, the investments that CAPs are making in network infrastructure are improving how the ISPs connect to other networks and online content, which helps ISPs in the delivery of their service to end users and lowers their costs.

<sup>31</sup> Refers to content that does not change depending on when it is accessed or by whom (e.g. streaming video from providers such as YouTube, TikTok, Netflix, among others).

<sup>32</sup> An Analysys Mason report shows that the use of the Netflix Open Connect CDN reduced transport costs for ISPs by USD1 billion in 2021. Analysys Mason (2022), *Netflix's Open Connect program and codec optimisation helped ISPs save over USD1 billion globally in 2021*. Available at <https://www.analysismason.com/netflix-open-connect>

maintain high levels of quality of experience for their shared end users. CAPs (including CDNs) began to connect to IXPs, where any ISP could peer and access their content. The process of networks peering and exchanging traffic with each other over IXPs is referred to as public peering. As the amount of traffic in the shared IXP switch grows, CAPs and ISPs may move to private peering, involving a direct connection between peering partners, which enables the partners to allocate capacity to ensure high-quality traffic exchange. Private peering often takes place in the same data center as the IXP. Further growth in traffic can result in a cache being embedded directly into the ISP's network, closer to the end users (this is also known as embedded or on-net caching). Each step described above – from connecting to an IXP to enable public peering, to embedding caches within ISP networks, involves increased investment on the part of the CAPs in order to lower the cost for ISPs to access content, and also to lower latency and improve end-user experience.<sup>33</sup>

These evolving arrangements are mutually beneficial: a content provider can deliver its content to customers who request it, with largely the same cost and quality irrespective of the ISP chosen by the end user; this ISP, in turn, is able to offer high-quality access to content to its subscribers while achieving cost savings as a result of CAP investments to bring traffic closer to end users. As a result, these arrangements largely remain settlement free. In some instances, ISPs and CAPs have engaged in negotiations and agreed on paid peering arrangements in which the CAP pays the ISP.

Overall, these voluntary interconnection arrangements contribute to the success of the internet in several ways.<sup>34</sup> The network of networks that results from interconnection is a core design principle determined by the founders of the internet, who valued openness and decentralization. As a result, networks themselves decide how and with whom to interconnect. This in turn demonstrates the openness and flexibility of the internet to networks regardless of location or technology, as long as they adopt common internet protocols, helping the internet to successfully grow and adapt to new users and new uses.

The value of openness and decentralization can be seen in how interconnection agreements have evolved over time in order to deliver high-bandwidth content such as video and gaming in a mutually beneficial arrangement between CAPs and ISPs. These agreements were tested by the increase of traffic on end users' domestic connections during the Covid-19 lockdowns and the resulting increase in traffic for work, study, and entertainment. During that time, ISPs and CAPs worked closely together. Streaming video companies reduced their resolution while networks adapted, and both CAPs and ISPs together enabled users to increase their home internet use. The flexibility that CAPs and ISPs exercise in determining their preferred interconnection arrangements with different partners demonstrates how the internet, through voluntary negotiated agreements between stakeholders, has been able to grow to improve consumer welfare with a wide variety of online choices, quality delivery, and low prices.

## 2.2 CAPs invest significant amounts in hosting, transport, and delivery networks

### Highlights

From 2018 to 2021, CAPs increased their levels of investment in hosting, transport, and delivery infrastructure to a total of USD120 billion annually, which is more than a 50% increase in investment from the 2014–17 timeframe. From 2011 to 2021, total cumulative investment by CAPs into internet infrastructure reached USD883 billion.

CAPs are carrying and paying for an increasing proportion of international traffic, which otherwise would be a cost that telecom carriers would have to incur. CAPs are also adopting a variety of strategies to improve their service delivery, bringing content closer to ISPs, while also contributing to investment in these areas, both directly and indirectly.

<sup>33</sup> CAPs and ISPs often work collaboratively to ensure that the needs of CAPs, ISPs, and end users are considered and balanced appropriately as interconnection evolves and investments related thereto are made.

<sup>34</sup> Analysys Mason (2021), *Study on the internet's Technical Success Factors*. Available at [https://report.analysismason.com/internet\\_success\\_factors/MKGRA669%20%20Report%20for%20APNIC%20LACNIC%20V3.pdf](https://report.analysismason.com/internet_success_factors/MKGRA669%20%20Report%20for%20APNIC%20LACNIC%20V3.pdf)

The internet value chain reflects the collaboration that exists in the context of interconnection, discussed above in Section 2.1, and more broadly in the financing, deployment, and operation of the infrastructure that underpins the internet.

As a basic process, when end users demand online information (content and applications from CAPs), this information has to flow from its origin, for example a data center somewhere in the world, connected to a CAP network (hosting infrastructure) to destinations (end-user devices, connected to an ISP's network).

To go from one to the other, content must move through a combination of network links on submarine and terrestrial cables (transport infrastructure). Content then reaches the 'edge' of the content provider's network (or that of its CDN provider) and is handed over to the ISP network through delivery infrastructure, effectively routers and servers that can send content across the border of the ISP's network, or even serve it from caches within the ISP's network.

These links in the internet value chain are illustrated below in Figure 2.1.

**FIGURE 2.1: INTERNET VALUE CHAIN SPLIT INTO THREE CLUSTERS OF CAP INVESTMENT: HOSTING, TRANSPORT, AND DELIVERY [SOURCE: ANALYSYS MASON, 2022]**

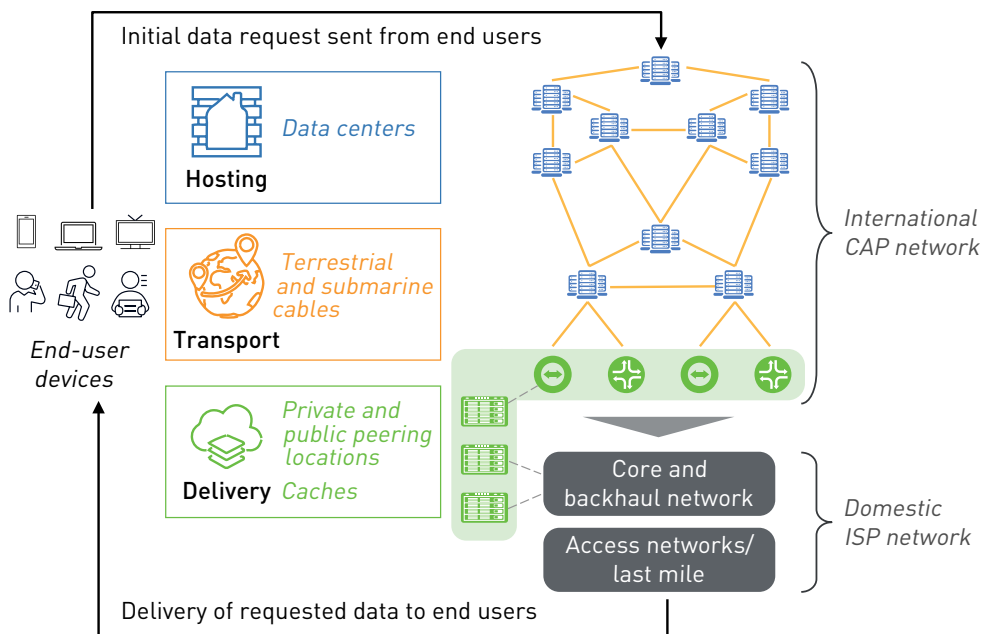

**2.2.1 From 2018 to 2021, CAPs spent over USD120 billion on average each year on internet infrastructure, reaching over USD480 billion in total over the four-year period**

Reflecting the view of the internet value chain presented in Figure 2.1 above, investments by CAPs are estimated in this report in three separate clusters of infrastructure: hosting (data centers and cloud), transport (cables transporting content), and delivery (peering and caching). We estimated investment in each of these clusters in reports published in 2014 (covering 2011–13),<sup>35</sup> and in 2018 (covering 2014–17).<sup>36</sup> During these timeframes, CAPs have continued to increase their investments in internet infrastructure, with annual spend between 2018 and 2021 reaching over three times the annual spend from 2011–13. This increase is driven by the growing demand for internet services from both new and existing users, along with the increasing demand for bandwidth-intensive content like video, gaming, and cloud services.

This investment includes **direct** spend by CAPs on these infrastructure items as part of capital expenditure (capex),<sup>37</sup> as well as **indirect** investment in the form of payments to third-party service providers (e.g. co-location data-center providers) that build the infrastructure used by CAPs.<sup>38</sup>

From 2018 to 2021, CAPs increased their levels of investment across all three of these areas to a total of USD120 billion annually. This is more than a 50% increase in investment from the 2014–17 timeframe. As shown in Figure 2.2, hosting (i.e. data centers) continues to be the most significant area where CAPs make investments in infrastructure, accounting for ~94% of investment since 2017 as CAPs continue to build their own data centers, while also investing indirectly in co-location at third-party data centers.

**FIGURE 2.2: AVERAGE ANNUAL INVESTMENT MADE BY CAPs** [SOURCE: ANALYSYS MASON, VARIOUS SOURCES, 2022]

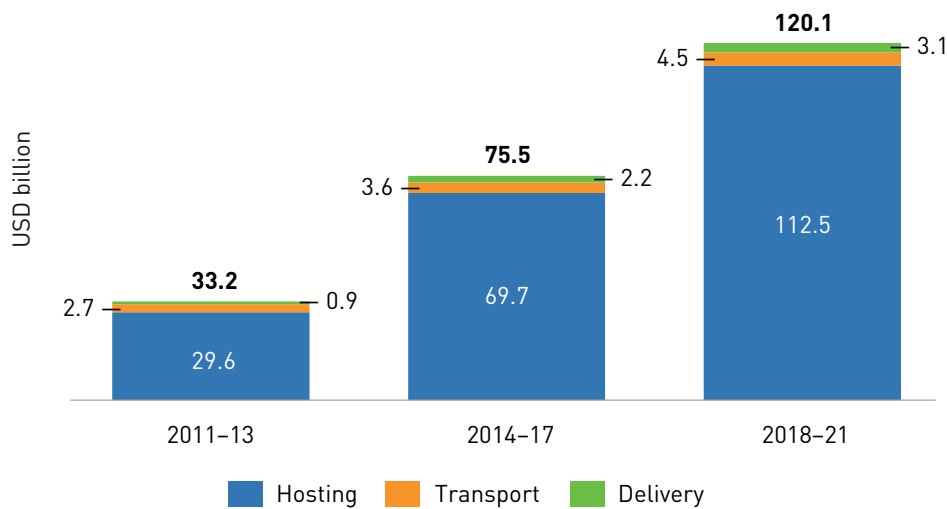

<sup>35</sup>Analysys Mason (2014), *Investment in networks, facilities and equipment by content and application providers*. Available at <https://www.analysismason.com/consulting-redirect/reports/content-application-provider-investment/>

<sup>36</sup>In Annex B, we set forth our methodology for the estimated investments and provide further detail.

<sup>37</sup>Capex typically refers to capital expenditure made to purchase assets that would generate income over the long term.

<sup>38</sup>We estimate indirect investment by CAPs on the basis of the price they pay these third-party service providers for services, which therefore includes an allowance for the risk and cost of capital that these data-center and backbone providers incur.

Investment by region is shown in Figure 2.3 below. North America continues to attract the largest regional share of CAP investment,<sup>39</sup> closely followed by Asia-Pacific, which has seen the most significant growth, and then Europe. Despite significant investments in countries such as Spain and Ireland,<sup>40</sup> Europe's

relatively low<sup>41</sup> cloud adoption has led to somewhat slower growth compared to other regions.<sup>42</sup> Meanwhile, there has been a rise in investment in Latin America as well as the Middle East and Africa, although these regions still only account for a small share of global investment.

**FIGURE 2.3: AVERAGE ANNUAL INVESTMENT BY REGION** [SOURCE: ANALYSYS MASON, VARIOUS SOURCES, 2022]

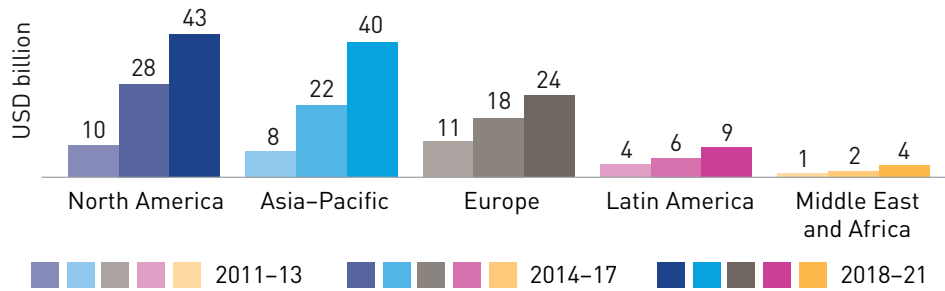
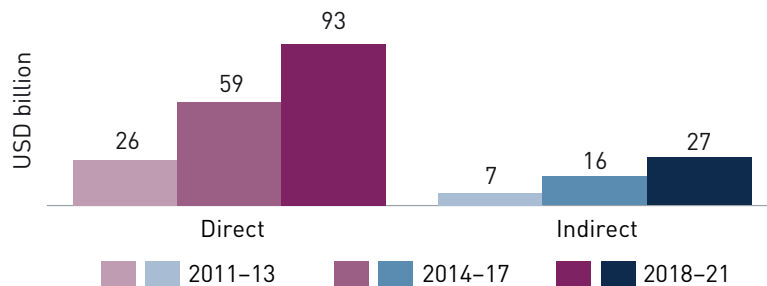

Figure 2.4 below shows that growth has occurred in both direct and indirect investment, as a result of growing demand for online services by end users. The majority of CAP spend continues to be direct

investment in their own infrastructure, as CAPs continue to self-supply their growing needs and control their infrastructure to manage long-term costs and performance.

**FIGURE 2.4: AVERAGE DIRECT AND INDIRECT ANNUAL INVESTMENT** [SOURCE: ANALYSYS MASON, VARIOUS SOURCES, 2022]



From 2011 to 2021, total cumulative investment by CAPs into internet infrastructure reached

USD883 billion in total over the 11-year period, as shown in Figure 2.5 below.

**FIGURE 2.5: CUMULATIVE INVESTMENT BY CAPs SINCE 2011 BY INFRASTRUCTURE CLUSTER** [SOURCE: ANALYSYS MASON, 2022]

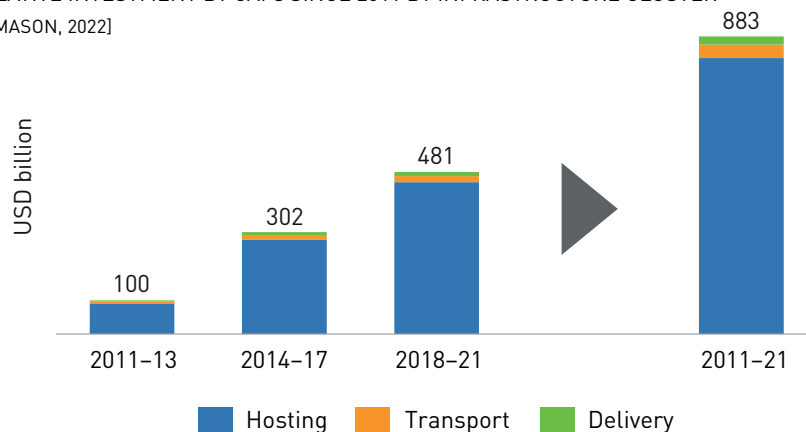

<sup>39</sup> North America is defined as the US and Canada; Mexico is included in Latin America.

<sup>40</sup> Synergy Research Group (2022), *Pipeline of Over 300 New Hyperscale Data Centers Drives Healthy Growth Forecasts*. Available at <https://www.srgresearch.com/articles/pipeline-of-over-300-new-hyperscale-data-centers-drives-healthy-growth-forecasts>

<sup>41</sup> Data Centre Magazine (2022), *Europe is having a reckoning with the cloud*. Available at <https://datacentremagazine.com/data-centres/europe-is-having-a-reckoning-with-the-cloud>

<sup>42</sup> The European Commission is actively planning to stimulate growth in cloud adoption and digitization of public and private services, through its Digital Decade/Digital Compass plans. See [https://ec.europa.eu/info/strategy/priorities-2019-2024/europe-fit-digital-age/europes-digital-decade-digital-targets-2030\\_en](https://ec.europa.eu/info/strategy/priorities-2019-2024/europe-fit-digital-age/europes-digital-decade-digital-targets-2030_en)

### 2.2.2 CAP spend on infrastructure across all clusters continues to increase, to support growth in the consumption and quality of content and cloud services

CAPs have increased their investments across the three infrastructure clusters of hosting, transport, and delivery, with the aim of improving the provision of content and cloud services to individuals and businesses.

More data centers are being deployed, and this deployment is also occurring in a growing number of regions across the globe, which increases the amount of storage and computing power available, while reducing the distance of these facilities to users. Growth in the number and size of data centers has led to an increase in spend on long-distance networks, in order to link these data centers to each other and to delivery networks. Meanwhile, spend on delivery networks has also increased, moving content ever closer to end users to improve the quality of experience while managing cost efficiency.

*Hosting continues to be the most significant area of CAP investment in infrastructure, accounting for over USD110 billion in annual spend between 2018 and 2021*

A large share of investment into hosting infrastructure is in self-built hyperscale data centers. These facilities exhibit significant power and cost efficiency, reliability, and performance benefits compared to traditional commercial data centers.

Some co-location providers have also started to build facilities to meet the requirements of specific CAPs and, in certain situations, are doing this through investment vehicles/joint ventures. CAPs are increasing the amount that they spend on co-location space in data centers from third-party providers, as this leasing of space allows CAPs to grow capacity in new markets at a much faster rate, and with lower upfront capital costs.

Smaller enterprises are increasingly favoring cloud services from CAPs as opposed to the more traditional leasing of co-location space directly from third-party data-center providers. Third-party co-location data center providers have therefore started to develop closer relationships with CAPs as these CAPs need increasing amounts of space for content, as well as cloud services that serve enterprises.

Synergy Research Group estimates that hyperscale operators were using up to 660 data-center facilities across all regions as of Q3 2021,<sup>43</sup> compared to roughly 390 at the end of 2017.<sup>44</sup> Many of these were located in North America,<sup>45</sup> but there has been significant growth in Asia-Pacific where there is an increased demand for online services. Asia-Pacific has the largest amount of cloud availability zones when including cloud operators with headquarters in China (Alibaba and Tencent), and there is now a similar number of cloud availability zones in North America and Asia-Pacific from cloud operators with headquarters in the US (Amazon, Microsoft, Google). This is illustrated in Figure 2.6.

**FIGURE 2.6:** NUMBER OF CLOUD AVAILABILITY ZONES BY REGION FOR MAJOR US-HEADQUARTERED (AMAZON, MICROSOFT AND GOOGLE) AND CHINA-HEADQUARTERED (ALIBABA AND TENCENT) CLOUD PROVIDERS AS OF 2022  
[SOURCE: COMPANY WEBSITES, ANALYSYS MASON, 2022]

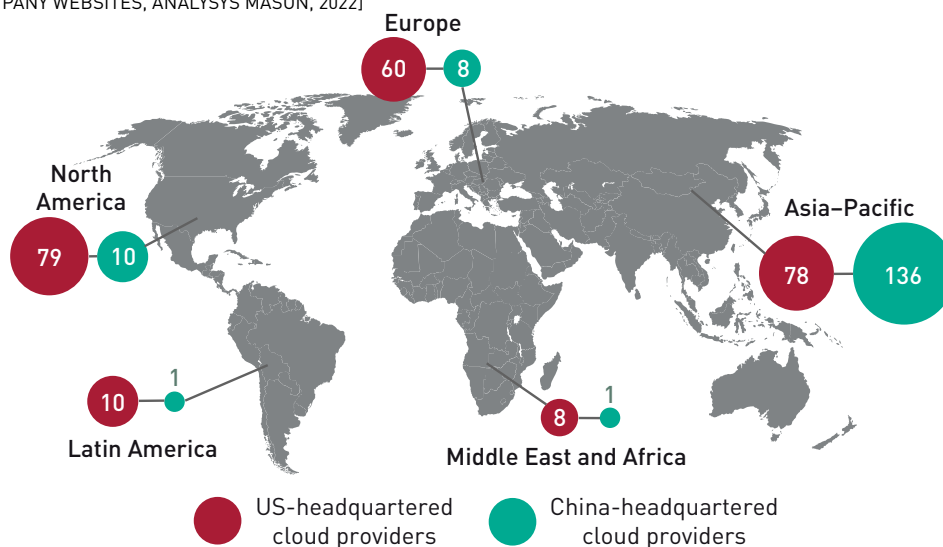

<sup>43</sup> Synergy Research Group (2022), *Hyperscale Data Center Count Grows to 659 – ByteDance Joins the Leading Group*. Available at <https://www.srgresearch.com/articles/hyperscale-data-center-count-grows-to-659-bytedance-joins-the-leading-group>

<sup>44</sup> Synergy Research Group (2017), *Hyperscale Data Center Count Approaches the 400 Mark; US Still Dominates*. Available at <https://www.srgresearch.com/articles/hyperscale-data-center-count-approaches-400-mark-us-still-dominates>

<sup>45</sup> Synergy Research Group (2022), *Pipeline of Over 300 New Hyperscale Data Centers Drives Healthy Growth Forecasts*. Available at <https://www.srgresearch.com/articles/pipeline-of-over-300-new-hyperscale-data-centers-drives-healthy-growth-forecasts>

CAP spending in transport infrastructure has grown, driven by increasingly direct investment, to USD4.5 billion per annum on average since 2018

CAPs continue to invest in transport infrastructure, including terrestrial or submarine cables, primarily to allow traffic to flow between data centers. The overall

demand for international bandwidth has continued to grow and CAPs have continued to account for an increasing share of this bandwidth, as shown in Figure 2.7. As a result of these investments, CAPs are carrying and paying for an increasing proportion of international traffic, which otherwise would be a cost that telecom carriers would have to incur.

**FIGURE 2.7: TOTAL INTERNATIONAL BANDWIDTH USED [SOURCE: TELEGEOGRAPHY,<sup>46</sup> 2022]**

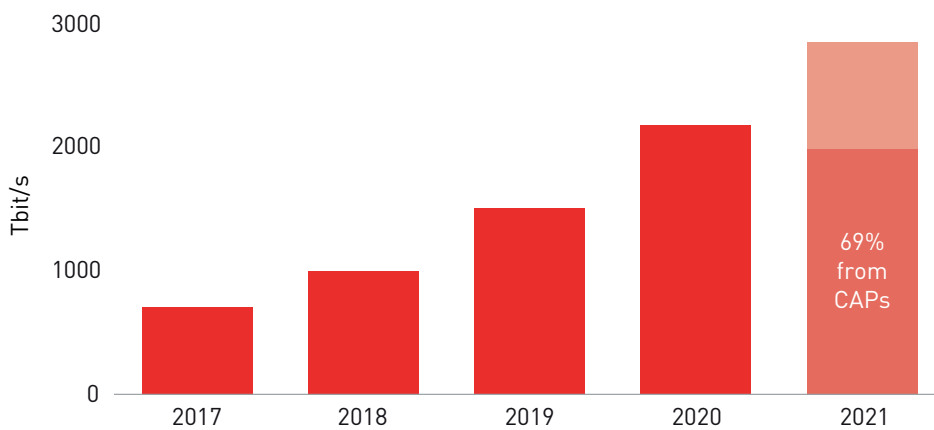

Historically, investment by CAPs in terrestrial cables has primarily been through indirect means, typically by leasing access to dark fiber based on 10-year to 20-year agreements. Where dark fiber is not available, CAPs have tended to lease capacity from backbone providers. Indirect investment in terrestrial cables continues to grow as CAPs can rapidly expand capacity and have greater certainty on cost over time. In certain areas, CAPs have also started to invest more directly in terrestrial fiber deployment, usually in partnership with a backbone provider, in the interest of improving connectivity.<sup>47</sup>

In recent years, large CAPs have begun to invest more directly in new submarine cable systems, either as part of a consortium of investors or, in a smaller number of cases, as anchor investors, where the CAP puts up 100% of the initial capital for the cable. There were 19 submarine cables with CAP ownership stakes that were announced as of 2018, and a further 14 cables with CAP ownership stakes announced after 2018,<sup>48</sup> bringing the total number of announced cables in

which CAPs have invested to 33 as of 2022, as shown in Figure 2.8. This figure includes cables expected to become ready for service as far out as 2024. The ownership stakes that CAPs take in new cables has increased, and CAPs also provide capacity to third parties on cables that are majority owned. CAPs are investing in regions that have historically had less access to international connectivity and are generally deploying submarine cables that are increasingly technologically advanced. These developments are discussed further in Annex B.

<sup>46</sup> TeleGeography (2022), *Content Providers Binge on Global Bandwidth*. Available at <https://blog.telegeography.com/content-providers-binge-on-global-bandwidth>

<sup>47</sup> See Annex B for examples of other investments and efforts made by CAPs that help to improve connectivity outside of the hosting, transport, and delivery clusters.

<sup>48</sup> The previous Analysys Mason report states that 22 submarine cables had been announced as of 2018; this number has since reduced to 19 cables, as the HKA and HK-G cables have been withdrawn and Bay to Bay Express was reconfigured as the CAP-1 cable system in 2020.

**FIGURE 2.8:** ANNOUNCED SUBMARINE CABLES IN WHICH CAPs HAVE INVESTED, AS OF 2022 [SOURCE: ANALYSYS MASON BASED ON INFORMATION FROM PRESS ARTICLES, TELEGEOGRAPHY,<sup>49</sup> 2022]

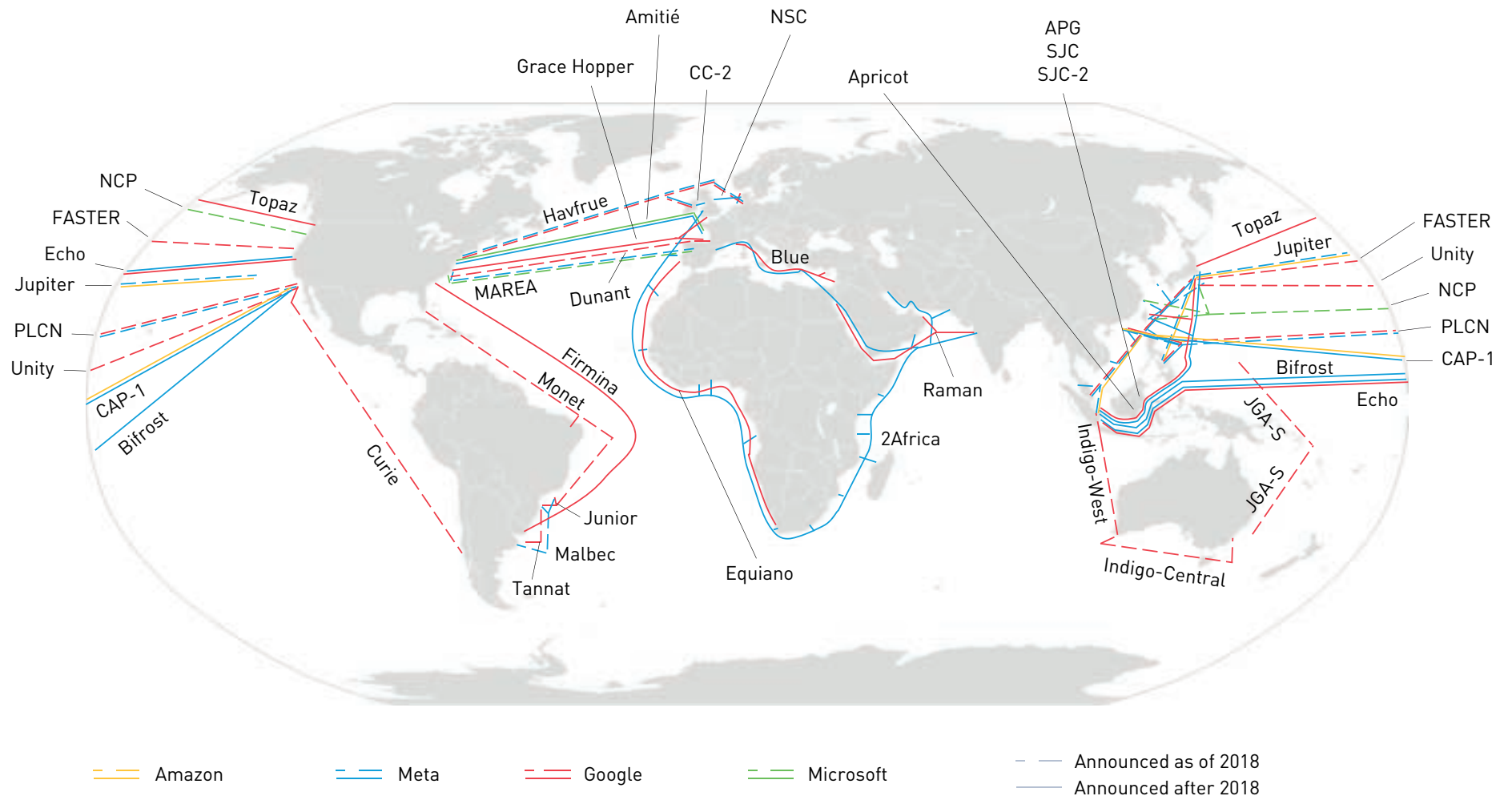

<sup>49</sup> TeleGeography (2022), *Submarine Cable Map*. Available at <https://www.submarinecablemap.com/>



CAPs continue to develop delivery networks to bring services closer to end users, through border gateways in IXPs, private peering facilities, and caches inside ISP networks

After moving through long-distance transport networks, content needs to flow through ISPs' networks to reach end users. This typically occurs through public peering at IXPs or through private peering, which as mentioned in Section 2.1 is a commercially negotiated arrangement between two or more parties. In some countries, including the US and Germany, peering tends to be concentrated in several regional hubs.<sup>50,51</sup> New IXPs continue to emerge across different regions, and established IXPs are also expanding their presence, both within<sup>52</sup> and across<sup>53</sup> regions. Other recent initiatives that IXPs have been developing to improve interconnection are discussed further in Annex B.

As part of the delivery infrastructure cluster, CAPs typically invest in both public and private peering locations.<sup>54</sup> This can either be directly through investment in technology like routers and ports for access, or indirectly by paying fees to internet exchanges for interconnection. The number of CAP points of presence at both public and private facilities has grown since 2018. The number of public peering points has increased by 80% since 2018 as CAPs expand their footprint to interconnect with more networks, and the number of facilities at which CAPs peer privately has increased by 35% over the same period,<sup>55</sup> as shown in Figure 2.9. While the number of public peering locations is greater than the number for private peering, the volume of traffic across private peering is much higher than public peering. Equinix reports that 90% of all traffic peered across its platforms is exchanged via private peering, with the remaining 10% of traffic exchanged via public peering.<sup>56</sup>

**FIGURE 2.9:** NUMBER OF GLOBAL INTERCONNECTION LOCATIONS USED FOR PUBLIC AND PRIVATE PEERING, FOR TEN<sup>57</sup> MAJOR CAPs [SOURCE: PEERINGDB,<sup>58</sup> ANALYSYS MASON, 2022]

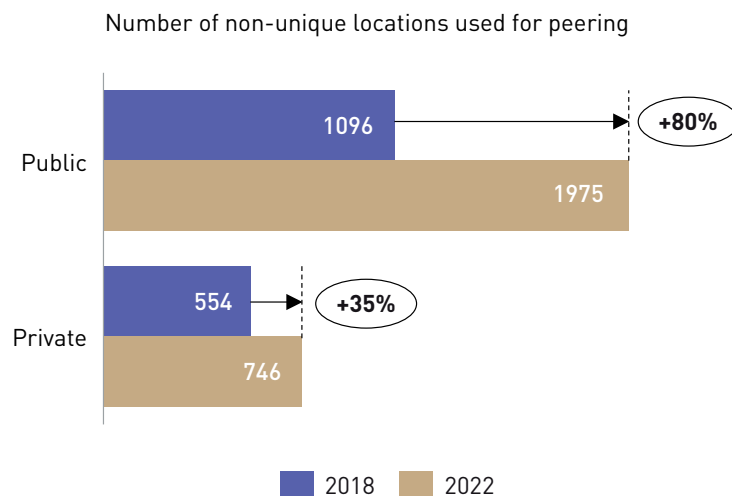

<sup>50</sup> DrPeering International, *The Evolution of the U.S. internet Peering Ecosystem*. Available at <https://drpeering.net/white-papers/Ecosystems/Evolution-of-the-U.S.-Peering-Ecosystem.html>

<sup>51</sup> WIK-Consult (2022), *Competitive conditions on transit and peering markets*. Available at [https://www.bundesnetzagentur.de/EN/Areas/Telecommunications/Companies/Digitisation/Peering/download.pdf;jsessionid=4F82FD1F00D8D8D2DA9A50CE6BCDBAED?\\_\\_blob=publicationFile&v=1](https://www.bundesnetzagentur.de/EN/Areas/Telecommunications/Companies/Digitisation/Peering/download.pdf;jsessionid=4F82FD1F00D8D8D2DA9A50CE6BCDBAED?__blob=publicationFile&v=1)

<sup>52</sup> For example, IX.br is a system of over 30 metropolitan interconnection points in Brazil.

<sup>53</sup> For example, LINX and DE-CIX are IXPs based in Europe, but that have since expanded to other global regions.

<sup>54</sup> Many public peering points overlap in larger metros.

<sup>55</sup> As reported by PeeringDB; many private peering locations are located in data centers where both parties in a private arrangement are located.

<sup>56</sup> Equinix (2022), *How to Solve for Peering Progression*. Available at <https://blog.equinix.com/blog/2022/03/24/how-to-solve-for-peering-progression/#:~:text=For%20all%20these%20reasons%2C%20private%20peering%20only%20makes,number%20of%20private%20peering%20partnerships%20is%20quite%20small.>

<sup>57</sup> The ten CAPs analyzed are Google, Meta, Microsoft, Amazon, Yahoo, Netflix, Apple, eBay, Tencent, Baidu.

<sup>58</sup> Accessed July 2022; see <https://www.peeringdb.com/>

Beyond investing in peering, CAPs also invest in CDNs to deliver traffic more efficiently. CDN infrastructure involves caching content closer to end users to minimize the distance needed to deliver content, which can improve the quality of experience and reduce costs. This caching of content can take place at peering locations but is increasingly also taking place in embedded (on-net) caches placed within ISP networks to get ever closer to end users.

CDNs are starting to play a more significant role due to the increased demand for bandwidth-intensive content such as video, gaming, and the growth of cloud services; storing content such as videos or software updates in caches closer to end users (as shown in Figure 2.10); and reducing the cost and latency of delivery.

**FIGURE 2.10: CONCEPT OF CONTENT DELIVERY WITH AND WITHOUT CACHING [SOURCE: ANALYSYS MASON, 2022]**

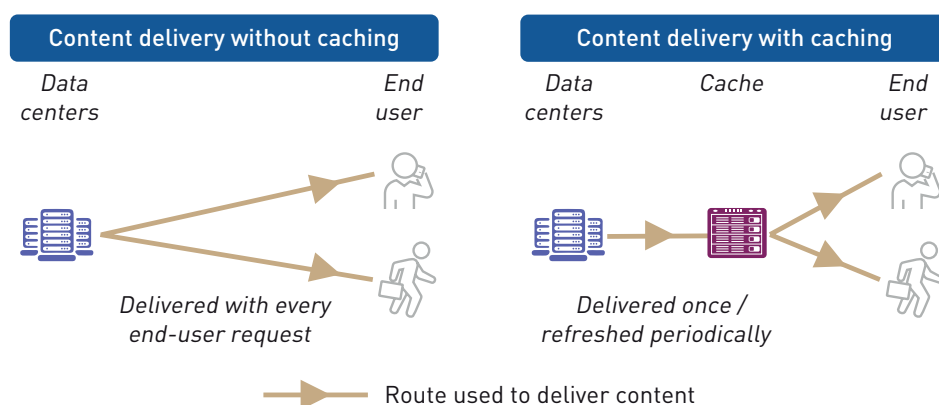

CAPs rely on a combination of:

- commercial CDN providers (e.g. Akamai)
- cloud CDNs offered by public cloud providers (e.g. Amazon CloudFront operated by Amazon Web Services, Google Cloud CDN)
- their own infrastructure.

Embedded (on-net) caches within ISP networks are expanding, both for CAPs' own use (e.g. Netflix Open Connect,<sup>59</sup> Google Global Cache, Meta Edge Appliance) and for third-party customers (e.g. Akamai, Google's Media CDN).<sup>60</sup>

The CDN space is dynamic and innovative. CAPs and technology vendors are developing new standards, including Open Caching as part of the Streaming Video Alliance to develop interoperable caching,<sup>61</sup> as described further in Annex B. Elsewhere, the development of CDN footprints are also being driven by more regional or domestic players such as IXPs. For

example, in Brazil, the OpenCDN initiative has been launched, which involves inviting CDN providers to deploy caches at various IX.br locations that can be shared by multiple ISPs at each location. This would make it easier for customers of the thousands of ISPs in Brazil to benefit from CDN services, while allowing CDN providers to deploy their cache footprints more efficiently.<sup>62</sup>

As demonstrated above and described further in Annex B, developments in both the peering and caching ecosystems continue to take place, driven by multiple stakeholder groups. As a result, CAPs are adopting a variety of strategies to improve their service delivery, bringing content closer to ISPs, while also contributing to investment in these areas, both directly and indirectly. The increase in the number of peering locations and caches and closer proximity to ISPs also help ISPs manage, control, and optimize their network costs, as discussed further in Section 3.

<sup>59</sup> Netflix. *Open Connect*. Available at <https://openconnect.netflix.com/en/>

<sup>60</sup> Google Cloud [2022], *Introducing Media CDN—the modern extensible platform for delivering immersive experiences*. Available at <https://cloud.google.com/blog/products/networking/introducing-media-cdn>

<sup>61</sup> Streaming Video Alliance. *What is Open Caching*. Available at <https://opencaching.streamingvideoalliance.org/what-is-open-caching/>

<sup>62</sup> OpenCDN, *About OpenCDN*. Available at <https://opencdn.nic.br/en/about/>

### 2.3 CAPs' investment in internet infrastructure has a positive impact on CAPs, ISPs, and the wider economy and society

#### Highlights

The investments that CAPs make in infrastructure enable greater levels of internet adoption and usage, which in turn result in a variety of macroeconomic benefits.

CAP investments in transport and delivery networks reduce costs for ISPs, as content is brought and stored closer to end users, potentially lowering

ISPs' prices to end users. These investments also reduce the time taken for content to reach the end user and help make the internet more reliable and stable during peak traffic.

CAPs' investment in internet infrastructure improves service performance, increases the reliability of CAP services, and improves CAPs' own economics. This, in turn, has been shown by various studies to drive overall internet penetration and usage, generating macroeconomic benefits through digitalization. Examples of the wider benefits of CAPs' investment in infrastructure are summarized in Figure 2.11.

**FIGURE 2.11: EXAMPLES OF THE WIDER BENEFITS OF CAPs' INVESTMENT IN INFRASTRUCTURE** [SOURCE: ANALYSYS MASON, COPENHAGEN ECONOMICS, DELOITTE, GOOGLE, RTI INTERNATIONAL, ITU, FROST & SULLIVAN, COMPILED IN 2022]

Description	Benefit
Increased GDP	<ul style="list-style-type: none"> <li>A study by Copenhagen Economics estimates that every USD1 of direct investment by Google in Europe can create USD1.35 of GDP through induced and indirect effects<sup>63</sup></li> <li>RTI estimates that Meta's expenditure on data centers from 2017 to 2019 contributed USD18.6 billion to the US GDP,<sup>64</sup> while investment in Marea and two other submarine cables with landing dates after 2024 are expected to bring USD82.8 billion to Europe's GDP on an annual basis<sup>65</sup></li> <li>Analysys Mason estimates that the benefits to sub-Saharan Africa stemming from Meta's connectivity initiatives in that region will likely exceed USD50 billion in GDP over 2020–24,<sup>66</sup> and also estimates that Google's USD2 billion investment in Asia-Pacific network infrastructure from 2010 to 2020 has created an estimated USD430 billion in additional GDP for the region<sup>67</sup></li> </ul>

<sup>63</sup> Copenhagen Economics (2019), *Google's Hyperscale Data Centers and Infrastructure Ecosystem in Europe*. Available at [https://copenhageneconomics.com/wp-content/uploads/2021/12/copenhagen-economics-google-european-dcs-infrastructures-impact-study\\_september2019.pdf](https://copenhageneconomics.com/wp-content/uploads/2021/12/copenhagen-economics-google-european-dcs-infrastructures-impact-study_september2019.pdf)

<sup>64</sup> RTI International (2020), *The Impact of Facebook U.S. Data Center Fleet*. Available at <https://www.rti.org/publication/impact-facebooks-us-data-center-fleet-2017-2019/fulltext.pdf>

<sup>65</sup> RTI International (2021), *Economic Impact of Meta's Subsea Cable Investments in Europe*. Available at <https://www.rti.org/publication/economic-impact-metas-subsea-cable-investments-europe/fulltext.pdf>

<sup>66</sup> Analysys Mason (2020), *The Impact of Facebook's Connectivity Initiatives in Sub-Saharan Africa*. Available at <https://www.analysismason.com/contentassets/f8a396952f9c4481982c674724d85356/the-impact-of-facebooks-connectivity-initiatives-in-the-ssa-region---30-june-2020.pdf>

<sup>67</sup> Analysys Mason (2020), *Economic Impact of Google's APAC Network Infrastructure*. Available at <https://www.analysismason.com/contentassets/b8e0ea70205243c6ad4084a6d81a8aa8/impact-of-googles-network-investments-in-apac---september.pdf>

Description	Benefit
<p><b>Job creation</b></p>	<ul style="list-style-type: none"> <li>• Frost &amp; Sullivan indicates that due to investment by CAPs, direct jobs are created in construction, maintenance, and management of network infrastructure,<sup>68</sup> while ITU indicates that indirect job creation is prominent in industries that can benefit most from improved internet connectivity and digitalization, namely IT, financial and professional services, and manufacturing<sup>69</sup></li> <li>• RTI International states that Meta's investments in data centers in 2010–16 contributed to the creation of 60 100 jobs<sup>70</sup></li> <li>• Copenhagen Economics indicates that Google's investment in data centers in Europe has created 6600 jobs per annum on average from 2007 to 2017. By 2021, Google's data-center investment will have supported a total of EUR15.2 billion of economic activity across Europe (2007–21), corresponding to 13 100 jobs per annum on average.<sup>71</sup> Direct jobs include positions in data-center management, mechanical and electrical maintenance, water management, and hardware operations, and jobs as systems technicians; indirect effects include jobs in security, catering, cleaning, and in the construction and supply industries<sup>72</sup></li> <li>• Africa Practice and Genesis Analytics estimate that Equiano, a submarine cable in which Google has invested, will indirectly create 1.6 million jobs in Nigeria, 180 000 in South Africa and 21 000 in Namibia between 2022 and 2025<sup>73</sup></li> <li>• Analysys Mason estimates that Google's infrastructure investments have created an estimated 1.1 million additional jobs in Asia–Pacific since 2010, and 401 000 jobs in Japan from investments in 2021, growing to an estimated 739 000 by 2026<sup>74</sup></li> </ul>
<p><b>Resource efficient / more environmentally friendly</b></p>	<ul style="list-style-type: none"> <li>• A report published by Google suggests that the delivery of data to and from cloud customers relies on CAP network infrastructure. Google estimates that a typical company migrating to the cloud would achieve a 68–87% reduction in energy on computing, and also a similar reduction in carbon emissions<sup>75</sup></li> <li>• Cloud services are based on shared infrastructure and computing resources which are utilized across multiple cloud customers, thereby maximizing the utility of resources</li> </ul>

<sup>68</sup> Frost & Sullivan (2010), *Report on Consultancy Study on Issues Relating to the Landing of Submarine Cables in Hong Kong*. Available at <https://docplayer.net/12540395-Report-on-consultancy-study-on-issues-relating-to-the-landing-of-submarine-cables-in-hong-kong.html>

<sup>69</sup> ITU (2012), *The Impact of Broadband on the Economy*. Available at [https://www.itu.int/ITU-D/treg/broadband/ITU-BB-Reports\\_Impact-of-Broadband-on-the-Economy.pdf](https://www.itu.int/ITU-D/treg/broadband/ITU-BB-Reports_Impact-of-Broadband-on-the-Economy.pdf)

<sup>70</sup> RTI International (2018), *The Impact of Facebook's U.S. Data Center Fleet*. Available at [https://www.rti.org/sites/default/files/facebook\\_data\\_centers\\_2018.pdf](https://www.rti.org/sites/default/files/facebook_data_centers_2018.pdf)

<sup>71</sup> Copenhagen Economics (2019), [https://www.copenhageneconomics.com/dyn/resources/Publication/publicationPDF/0/500/1569061077/copenhageneconomics-google-european-dcs-infrastructures-impact-study\\_september2019.pdf](https://www.copenhageneconomics.com/dyn/resources/Publication/publicationPDF/0/500/1569061077/copenhageneconomics-google-european-dcs-infrastructures-impact-study_september2019.pdf)

<sup>72</sup> Copenhagen Economics (2018), *European data centres How Google's digital infrastructure investment is supporting sustainable growth in Europe*. Available at <https://www.copenhageneconomics.com/dyn/resources/Publication/publicationPDF/6/426/1519115098/copenhageneconomics-2018-european-data-centres.pdf>

<sup>73</sup> Africa Practice and Genesis Analytics (2021), *Equiano Subsea Cable: Regional Economic Impact Assessment*. Available at <https://genesis.imgix.net/uploads/files/Equiano-Regional-Economic-Impact-Assessment-6-October-2021.pdf>

<sup>74</sup> Analysys Mason (2022), *Economic Impact of Google's APAC Network Infrastructure 2022 Update -focus on Japan*. Available at <https://www.analysismason.com/contentassets/726905c173f54ab8a95f910a75b20e77/analysys-mason---economic-impact-of-googles-apac-network-infrastructure-report-2022-update---focus-on-japan.pdf>

<sup>75</sup> Google (2012), *Google Apps: Energy Efficiency in the Cloud*. Available at <https://static.googleusercontent.com/media/www.google.com/en//green/pdf/google-apps.pdf>

Description	Benefit
Other	<ul style="list-style-type: none"> <li>A study by Deloitte shows that Meta's investment in CAP infrastructure results in increased availability of information, services, and digital tools, especially in developing countries, and can improve learning (14% of internet users take at least one online course per annum); financial inclusion (a 1% increase in internet take-up should increase the number of banked people by 0.42%); and can reduce the number of deaths due to greater access to healthcare information for patients and practitioners (a 1% increase in internet take-up should reduce deaths by 0.15% on an annual basis)<sup>76</sup></li> </ul>

In addition, infrastructure investments by CAPs also more immediately impact the economics of broadband ISP networks in several ways:

- Investments that CAPs make in caches and CDNs generate benefits for the internet ecosystem by reducing the costs of delivering traffic for ISPs, as content is stored closer to end users, which in competitive broadband markets typically results in lower prices for end users. These investments also reduce the time taken for content to reach the end user and help make the internet more reliable and stable during peak traffic.
- CAPs' spend on transport networks, which is increasingly taking place through direct investment, effectively substitutes what ISPs would otherwise have to spend, and potentially also exceeds the amount that ISPs would otherwise spend themselves.

The impact of CAP investment on costs for ISPs is considered in more detail in Section 3.

<sup>76</sup> Deloitte (2014), *Value of Connectivity, economic and social benefits of expanding internet access*. Available at [https://www2.deloitte.com/content/dam/Deloitte/ch/Documents/technology-media-telecommunications/2014\\_uk\\_tmt\\_value\\_of\\_connectivity\\_deloitte\\_switzerland.pdf](https://www2.deloitte.com/content/dam/Deloitte/ch/Documents/technology-media-telecommunications/2014_uk_tmt_value_of_connectivity_deloitte_switzerland.pdf)

### 3 Investments by CAPs in transport and delivery networks save ISPs an estimated USD5.0–6.4 billion annually

Investments by CAPs in infrastructure are an essential part of the overall internet value chain, and are growing more rapidly, albeit from a lower base, than investments by ISPs in their networks. In some cases, these CAP investments are incremental to those that ISPs would make (e.g. data-center and other hosting investments); in other cases, however, CAPs invest in transport networks that ISPs would have had to build otherwise.

This section describes the impact of CAPs' investment in infrastructure on ISPs. ISPs and other proponents of network usage fees are advocating that CAPs should compensate ISPs for the traffic-sensitive part of ISPs' cost base and their related investments in their access networks to end users. However, these arguments tend to ignore the role of end-user choice in determining the level of traffic demand, as well as the interdependence of ISP and CAP services and investments in the global internet infrastructure.

In Section 3.1, we discuss the impact of CAP investment on ISPs as first and foremost an impact on demand: consumers and businesses connect to the internet to make use of the wide range of online services, applications, and associated content. As such, the demand for online services and the demand for broadband are inherently linked, and both are ultimately driven by end-user choices.

In Section 3.2, we address the question of ISPs' costs, to ascertain the scale of expenditure that is sensitive to traffic. We show that these costs, while significant, represent a relatively limited share of network costs, particularly in the fixed networks that, today, deliver the vast majority of internet traffic. Costs that are not traffic sensitive, including the costs of deploying ISPs' fiber access networks, represent a much greater share of network costs. Our analysis shows that the impact of internet traffic on network costs is relatively small, and network costs (traffic-sensitive or not) grow much more slowly than traffic itself. Operators have several additional avenues that they can use to control network costs in the future, which are also discussed in this section.

In Section 3.3, we explore the steps CAPs are taking to help mitigate traffic-sensitive costs, in close partnerships with ISPs. CAPs' investments in transport and delivery infrastructure reduce the need for most ISPs around the world to collect traffic internationally and have ensured that the demand for and cost of transit remains manageable for ISPs (as well as CAPs themselves). Intelligent caching is further mitigating the cost impact of increasing demand for content, by enabling ISPs to serve content close to their end users, in parts of the network that are less traffic sensitive.

#### 3.1 Demand for connectivity is intrinsically linked to demand for online services, with strong synergies recognized by CAPs and ISPs through marketing partnerships

##### Highlights

Demand for online services provides clear opportunities for ISPs to sell top-end connectivity solutions to high data users.

A significant amount of the demand for broadband services is driven by end users who decide to access online services and content from CAPs, as well as enterprises that use cloud services provided by CAPs to support their requirements.

Delivery of internet traffic is primarily driven by the choices of end users, to consume specific types of content from specific providers at an optimal quality of experience and for a suitable price.

End users typically purchase broadband services to access content and applications available on the internet. As demand for online services evolves, so does demand for broadband services. Demand for improved quality of online services, as well as new applications, is also accompanied by increased demand for faster broadband services.

Figure 3.1 below illustrates how demand for online services, in particular video streaming and gaming, is correlated with higher current average broadband speeds, as well as interest in higher future speeds for subsequent broadband package purchases. This provides clear opportunities for ISPs to sell top-end connectivity solutions to those high data users, at

prices that reflect the cost of delivering high volumes of traffic, with a high quality of experience, to users with a higher willingness to pay. It is worth noting that the demand that users have for top-end connectivity solutions is impacted by the marketing that ISPs engage in.<sup>77</sup>

**FIGURE 3.1: CORRELATION BETWEEN USE OF APPLICATIONS AND HIGH DEMAND FOR CURRENT AND FUTURE BROADBAND SPEEDS, IN THE US, EUROPE, AND DEVELOPED ASIA-PACIFIC (DVAP)**

[SOURCE: ANALYSYS MASON RESEARCH CONSUMER SURVEY, 2021]

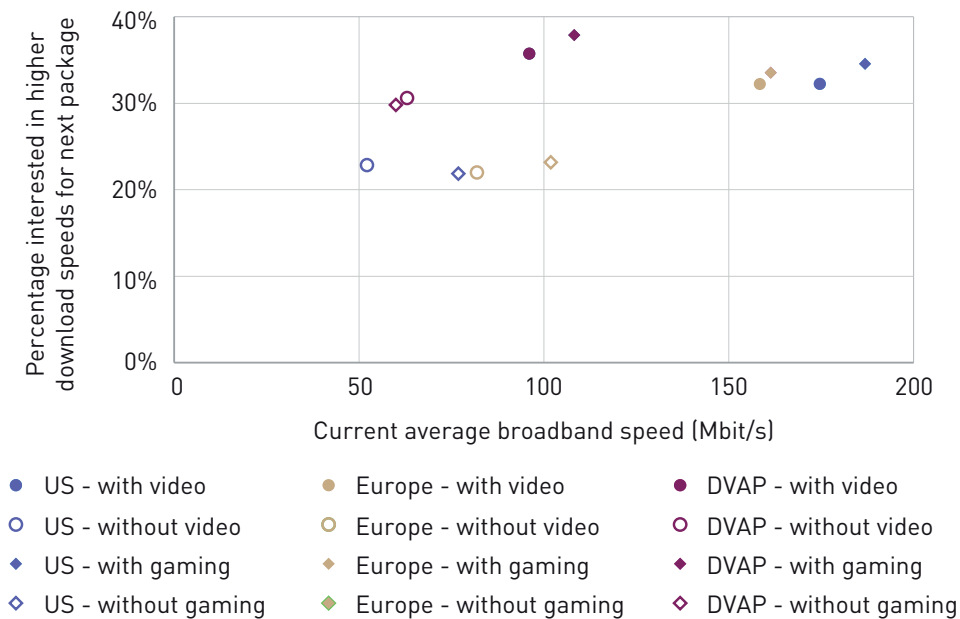

Providing higher speeds and higher volumes of traffic requires investment. In a competitive market, serving differentiated needs and monetizing higher willingness to pay is also the way to optimize consumer benefits and profits, through effective segmentation. According to the Analysys Mason Research Consumer Survey, broadband customers across the world, when asked about factors for choosing broadband providers, would often cite price as the most important. However, the survey also found that the most important factor affecting actual intention to churn from a provider is dissatisfaction with speeds, particularly in North America and Europe.<sup>78</sup> In other words, although internet users may choose a provider based on price, they choose to stay with that provider because of quality.

As shown in the Sandvine Global Internet Phenomena Report published in January 2022, over half of all traffic demanded by end users globally in the first half of 2021 was for video streaming content. The top-five application categories of video streaming, social, web, gaming, and messaging accounted for ~87% of traffic combined.<sup>79</sup> The largest global CAPs generally tend to operate across several application categories, and a significant amount of the demand for broadband services is driven by end users deciding to access online services and content from these companies.<sup>80</sup> While large global CAPs see significant demand for their services from end users in many different parts of the world, many third parties also use services provided by CAPs to support their cloud needs. Moreover, more domestic or regional CAPs are also

<sup>77</sup> For an example of how ISP marketing affects consumer demand for top-end connectivity solutions, see <https://www.fiercetelecom.com/broadband/third-broadband-switchers-want-symmetrical-speeds>

<sup>78</sup> Analysys Mason Research (2021), *Consumer Survey 2020: fixed broadband retention and satisfaction in Europe and the USA*. Available at <https://www.analysismason.com/research/content/reports/fixed-broadband-europeusa-rdmb0/>

<sup>79</sup> Sandvine (2022), *The Global Internet Phenomena Report January 2022*. Available at [https://www.sandvine.com/hubfs/Sandvine\\_Redesign\\_2019/Downloads/2022/Phenomena%20Reports/GIPR%202022/Sandvine%20GIPR%20January%202022.pdf?hsCtaTracking=18fff708-438e-4e16-809d-34c3c89f4957%7C067d9d28-ef90-4645-9d46-c70d10279247](https://www.sandvine.com/hubfs/Sandvine_Redesign_2019/Downloads/2022/Phenomena%20Reports/GIPR%202022/Sandvine%20GIPR%20January%202022.pdf?hsCtaTracking=18fff708-438e-4e16-809d-34c3c89f4957%7C067d9d28-ef90-4645-9d46-c70d10279247)

<sup>80</sup> We note that large CAPs also tend to use CDNs, including both in-house CDNs as well as those provided by third parties such as Akamai, to deliver content and services demanded by end users.

likely to account for a significant share of end-user demand for content in particular countries or regions.<sup>81</sup>

The importance of high-quality online services and content to the level of demand for broadband connections is also clear from the extensive co-marketing between the two. For example, Free in France ran a major campaign with Netflix around Season 4 of *Stranger Things*;<sup>82</sup> in many developing markets, where mobile is the primary means of accessing the internet,<sup>83</sup> mobile data packages are sometimes tailored to bundle access to specific online services, including messaging and social media provided by the main CAPs.<sup>84,85</sup> More generally, CAPs and ISPs have also collaborated on a wider variety of areas beyond co-marketing, including network transformation and productivity improvements, better customer care, and new business opportunities.<sup>86</sup>

Some arguments made within the context of the network usage fee debate have framed the delivery of traffic as being 'driven' by certain large CAPs,<sup>87</sup> or that such CAPs 'account for' a certain large percentage of traffic in a country.<sup>88</sup> These arguments essentially characterize CAPs as being responsible for traffic.

While it is the case that a handful of large CAPs deliver a significant share of the traffic demanded by end users, it does not then follow that these companies are 'responsible' for the traffic, or that they are not investing in network capacity.<sup>89</sup> It is ultimately the choices made by end users that result in traffic delivery. These choices have an impact on the justification for a network usage fee, as described below in Section 4.

### 3.2 Traffic volumes drive a relatively small share of costs for ISPs, and technological advancements in network technology lead to continuous reductions in unit costs

#### Highlights

Growth in traffic has not been accompanied by corresponding increases in network costs, as significant portions of ISPs' networks are not sensitive to traffic. Traffic-sensitive core and backhaul costs tend to only account for a small share of costs: we estimate that traffic-sensitive costs in the core and backhaul of fixed networks typically account for 20–30% of network costs, and 10–15% of revenue.

The trend of network costs remaining relatively stable while traffic volumes grow, is expected to continue in future, particularly as fixed networks move toward fiber-based architectures, and as mobile technologies evolve to enable operators to add network capacity more efficiently.

Investments made by CAPs in facilitating peering at interconnection points or deploying caches within ISP networks are also helping ISPs to manage costs.

As broadband speeds increase, end users can do more with their internet connection; when enough people in a country and globally have access to sufficiently fast connections, new, richer services develop. These services spur further demand for faster connectivity and lead to greater data traffic. As explained in Section 3.1, this traffic is primarily driven by the choices of end users.

<sup>81</sup> For example, ZDFmediathek and ARD Mediathek are popular in Germany; see [https://www.bundesnetzagentur.de/EN/Areas/Telecommunications/Companies/Digitisation/Peering/download.pdf?\\_\\_blob=publicationFile&v=1](https://www.bundesnetzagentur.de/EN/Areas/Telecommunications/Companies/Digitisation/Peering/download.pdf?__blob=publicationFile&v=1)

<sup>82</sup> Free (accessed July 2022). <https://www.free.fr/jeu-concours/stranger-things-4/>

<sup>83</sup> Typically using mobile data, as fixed broadband networks tend to be less mature in developing markets.

<sup>84</sup> For example, MTN, a mobile operator in Africa, offers 'social bundles'; See <https://www.mtn.ng/personal/data/goodybag-social/> and <https://www.mtn.co.za/Pages/MTN-Social-Bundles.aspx/>

<sup>85</sup> It should be noted that certain jurisdictions (such as, recently, the European Union) do not allow such practices. See <https://www.ibanet.org/article/DAAB099C-A736-4ED7-BB4D-4719A1593A5F>

<sup>86</sup> Analysys Mason (2017), *Operators' digital transformation: unlocking EUR15 billion through partnerships with CAPs*. Available at <https://www.analysysmason.com/consulting-redirect/reports/operators-digital-transformation/>

<sup>87</sup> European Telecommunications Network Operators' Association (2022), *Europe's Internet ecosystem: A 72bn boost to GDP and 840k new jobs are within reach if gaps in network costs are tackled*. Available at <https://etno.eu/news/all-news/735:eu-internet-ecosystem.html>

<sup>88</sup> Forbes (2022), *The Growing Global Movement For Fair Cost Recovery On Broadband Networks*. Available at <https://www.forbes.com/sites/roslynlayton/2022/05/12/the-growing-global-movement-for-fair-cost-recovery-on-broadband-networks/?sh=3767831427a2>

<sup>89</sup> The relationship between content and carriage has been established since the start of the twenty-first century, when arguments were made suggesting that it was the broadband providers that were 'free-riding'.



All of these things have a cost: networks must be built, upgraded, and maintained; to offer greater speed and reliability, ISPs are deploying fiber optics deeper in networks, increasingly all the way to end user's homes and offices; to carry more traffic, ISPs must invest in new, higher-bandwidth links and equipment. The value chain for these investments is increasingly complex, but broadly speaking there are service providers (fixed ISPs, mobile operators) that run 'active' network equipment that move internet bits and voice calls, as well as infrastructure providers, which tend to build and operate 'passive' infrastructure including mobile masts and fiber-optic cables and which serve ISPs, CAPs, and large enterprise users.

### 3.2.1 Growth in network-related costs has remained relatively low and stable, despite significant growth in traffic levels

Since 2018, global traffic delivered over fixed and mobile access networks has increased significantly; over this same period, network-related annual spend by telecom operators has remained relatively stable. Figure 3.2 below illustrates how network-related telecom operator costs, approximated as the sum of network operating expenditure (network opex<sup>90</sup>) and total capex, has increased only slightly between 2018 and 2021, while traffic grew significantly over the same period.

**FIGURE 3.2:** GROWTH IN TRAFFIC DELIVERED OVER FIXED AND MOBILE ACCESS NETWORKS, AND EVOLUTION OF NETWORK-RELATED TELECOM OPERATOR COSTS FROM 2018 TO 2021 [SOURCE: ANALYSYS MASON, 2022]

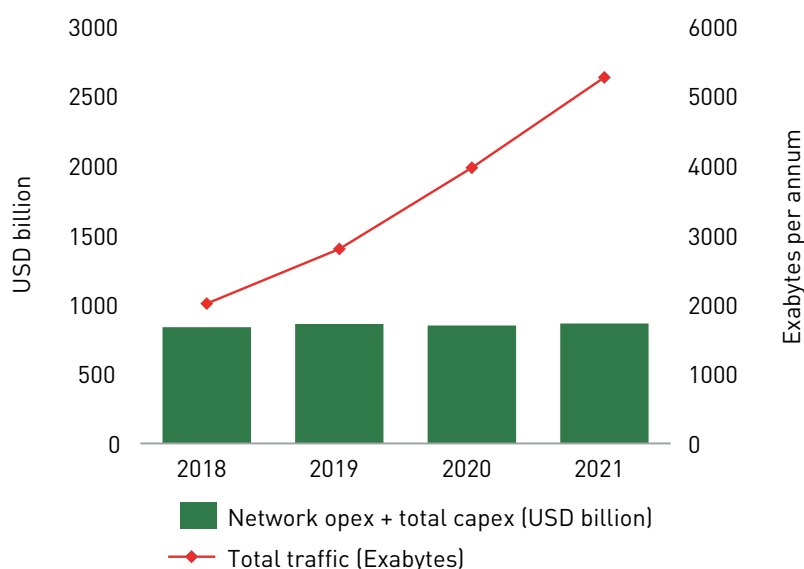

A key factor behind network costs remaining relatively stable while traffic increases, is that equipment costs tend to fall over time while the capacity of network equipment also continues to grow and, as a result, the unit cost of traffic declines over time. For example, high-capacity routers<sup>91</sup> and dense wavelength-division

multiplexing (DWDM) equipment have become significantly more advanced, meaning that as networks are upgraded with new equipment, they are able to handle traffic volumes more efficiently.<sup>92</sup>

<sup>90</sup> Operating expenditure refers to expenses that companies incur to support day-to-day operations.

<sup>91</sup> There are large economies of scale in routing equipment (e.g. the cost of a 100G connection could be only ~2-3 times as much as a 10G connection). This means that the unit cost of traffic in a network handling more demand per link can be significantly lower than unit costs in a network that handles less demand per link.

<sup>92</sup> This can be seen as an example of Moore's Law. See WIK-Consult (2014), *The economic impact of internet traffic growth on network operators*. Available at [https://www.wik.org/uploads/media/Google\\_Two-Sided\\_Mkts.pdf](https://www.wik.org/uploads/media/Google_Two-Sided_Mkts.pdf)

Another important reason why network costs remain relatively stable as traffic grows is that significant portions of ISP networks are not sensitive to traffic to begin with. Broadband ISP networks are usually divided into the core and backhaul segments, as well as the

access segment. Examples of modern ISP network architectures, for converged, fixed-only, and mobile-only networks, are illustrated in Figure 3.3 below.

**FIGURE 3.3: EXAMPLES OF MODERN ISP NETWORK ARCHITECTURES**  
[SOURCE: ANALYSYS MASON, 2022]

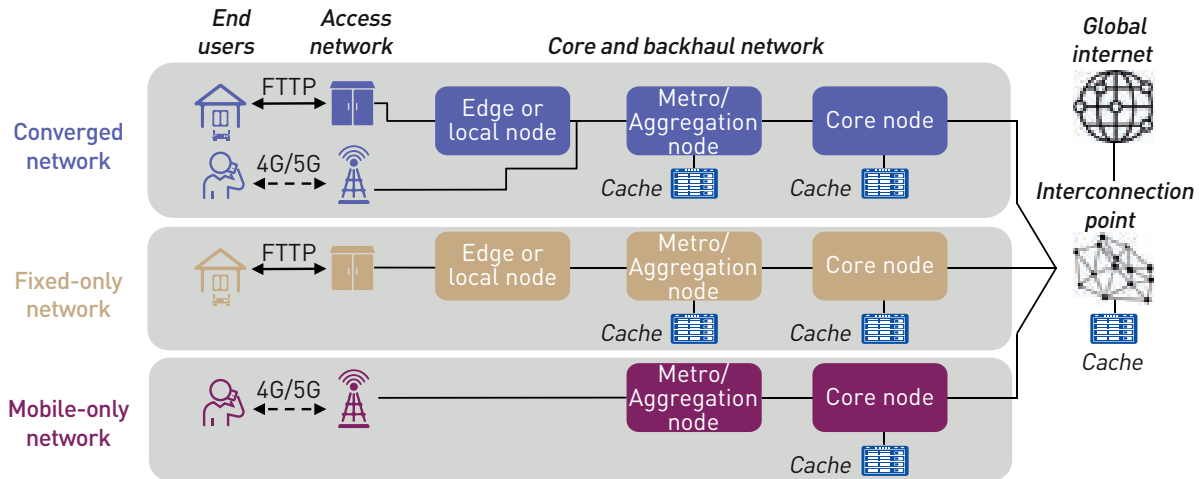

Note: FTTP = fiber to the premises

Costs for the core and backhaul segments tend to be more sensitive to traffic than in the access segment. This is particularly true in fixed networks, where access costs do not scale with traffic, as discussed further in Section 3.2.2. Investments made by CAPs in deploying caches at interconnection points or within ISP networks are also helping ISPs to manage costs. The impact of these investments is explained further in Section 3.3.

The trend of network costs remaining relatively stable while traffic volumes grow is expected to continue in future, particularly as fixed networks move toward fiber-based architectures (which are less expensive to operate than legacy alternatives<sup>93</sup>), and as mobile technologies evolve to enable operators to add network capacity more efficiently.

**3.2.2 In fixed networks, traffic-sensitive costs are mainly in the core and backhaul segments, with competition and technology upgrade the main drivers of costs in access networks**

Fixed networks carry the vast majority of traffic to end users in developed economies, and fixed access network costs are largely insensitive to traffic. Infrastructure deployment is driven by the location of end-user premises and the technology used (which also determines speeds), rather than the amount of traffic carried on the network.<sup>94</sup>

Meanwhile, fixed access networks are connected to the wider internet via the backhaul and core segments within a given ISP's network, linked to interconnection points. These segments aggregate traffic flowing to and from many connections in the access network and therefore become more traffic sensitive, as sufficient capacity needs to be provisioned in the links and nodes connecting different layers of the network. This results in costs in the form of equipment placed at nodes, and costs to link them, either through building links directly, or by means of wholesale connectivity. These

<sup>93</sup> Fiber Broadband Association (2020), *Reduce network operating expenses, choose FTTH*. Available at <https://optics.fiberbroadband.org/Full-Article/reduce-network-operating-expenses-choose-ftth>

<sup>94</sup> Described further in Annex C.

core and backhaul costs tend to only account for a small share of costs: we estimate that traffic-sensitive costs in the core and backhaul of fixed networks typically account for 20–30% of network costs, and 10–15% of revenue.<sup>95</sup>

Furthermore, ISPs that have relied on copper networks or coaxial cable are re-engineering their networks and deploying FTTP and retiring their legacy networks.<sup>96</sup> The performance of fiber optics in access networks is significantly less sensitive to distance than the legacy networks. The transition to full-fiber networks will allow ISPs to decrease the number of nodes in their networks, which will help reduce costs in the future.<sup>97</sup> Moreover, all-fiber networks have lower operational costs than legacy networks. A report published by the Fiber Broadband Association in 2020 suggests that opex for FTTH is 50% to 63% lower per home passed compared to the legacy technologies of HFC and DSL respectively.<sup>98</sup> Decommissioning legacy copper networks and running an all-FTTP access network could also reduce energy usage significantly, with Analysys Mason Research estimating reductions of up to 80%.<sup>99</sup> These effects can result in significant savings for ISPs. In the UK, BT announced in September 2022 that it expects to achieve savings of GBP500 million by March 2031, by shutting down the legacy public switched telephone network and shifting from copper to fiber.<sup>100</sup>

It is worth noting that some proponents of network usage fees argue that traffic-dependent payments should be made by CAPs in order to fund fiber deployment; however, it is the core and backhaul costs that are traffic sensitive, not the costs related to traffic delivery in the ISPs' access networks. We discuss this in further detail in Section 4.

### 3.2.3 In mobile networks, traffic drives the deployment of additional capacity in high-traffic areas, through a combination of additional spectrum, more efficient technology, and new equipment

Compared to fixed networks, mobile access networks are more sensitive to traffic: for a given mobile network technology (3G, 4G, 5G) the amount of capacity available on each site is limited by the amount of spectrum and antennas deployed, and is shared between mobile users connected to a given site. This means that the performance of each user's connection is dependent on what other users are doing. To maintain performance and speeds, operators must deploy more capacity in congested sites (through more spectrum, antennas, or technology upgrades), or deploy new sites nearby to spread the demand. Although mobile access networks are sensitive to traffic, there are three main factors that limit the impact of traffic on mobile ISP economics.

First, mobile data tariffs are highly segmented, to ensure that consumers who use more data pay more. This mechanism allows mobile operators to send a price signal to the market in order to help manage costs. Unlike fixed broadband offerings, mobile offerings tend to have data caps, and the cap varies depending on the price paid by the end user. This means that use of data by customers is correlated, if not directly proportional, to spend.

Second, a material proportion of mobile access network costs is associated with providing coverage in rural and suburban areas. Many cellular sites in these areas do not become congested in the same way as sites in denser areas. This type of site is therefore relatively insensitive to traffic once deployed. It is not unusual for these less traffic-sensitive areas to account for between half and three-quarters of the mobile points of presence in a country,<sup>101</sup> although this is quite variable depending on the topographic and demographic characteristics of each country.<sup>102</sup>

<sup>95</sup> In some markets like the UK, where ISPs can access a combination of competitively priced and price-regulated wholesale inputs, we have estimated that annualized traffic-sensitive network costs for a typical large ISP would amount to a lower proportion of cost and revenue.

<sup>96</sup> In addition to the performance characteristics of fiber, some regulators (e.g. in Europe) have set rules for the migration process and copper switch-off. For more details, see Annex C.

<sup>97</sup> Examples of the extent to which nodes would be rationalized are provided in Annex C.

<sup>98</sup> HFC refers to hybrid fiber coaxial; DSL refers to digital subscriber line. See <https://www.fiberbroadband.org/d/do/3686>

<sup>99</sup> Analysys Mason Research (2022), *Energy costs and ESG goals are pushing reducing network energy usage to the top of operators' agendas*. Available at <https://www.analysismason.com/research/content/articles/operator-energy-reduction-rdnt0-rdfi0/>

<sup>100</sup> Telecom TV (2022), *BT eyes savings of £500m by pulling the plug on legacy fixed networks*. Available at <https://www.telecomtv.com/content/access-evolution/bt-eyes-savings-of-500m-by-pulling-the-plug-on-legacy-fixed-networks-45333/>

<sup>101</sup> Based on geoanalysis performed by Analysys Mason during relevant project engagements from 2020–22.

<sup>102</sup> Coverage requirements also influence these effects: mobile network operators (MNOs) that commit to deploying in more rural areas as part of their license obligations will have relatively more coverage-driven sites than MNOs that deploy purely based on commercial incentives.

Finally, ongoing developments in mobile technology, as well as network sharing, increasingly allow operators to add capacity at lower incremental cost. These developments include the use of newly assigned spectrum bands or refarming of legacy spectrum to new technologies, the introduction of multi-band antennas and network virtualization,<sup>103</sup> as well as ongoing improvement in spectral efficiency and sharing, which allows more data to be carried over a given quantity of spectrum.<sup>104</sup> Ongoing developments that drive increasing levels of infrastructure sharing (through infrastructure providers such as tower companies and network-as-a-service players), as well as network virtualization and disaggregation,<sup>105</sup> are expected to further help mobile operators manage network costs.<sup>106</sup>

### 3.3 Investments made by CAPs in transport and delivery networks help ISPs to mitigate costs

#### Highlights

Investments made by CAPs reduce the backbone and backhaul capacity that ISPs need to provide to deliver a given amount of content to their end users, and further mitigate ISP network investments even as demand continues to grow, both in terms of traffic and quality of experience.

In fixed networks, core and backhaul costs are the main traffic-sensitive cost components and represent just ~20% of network costs; network costs in turn represent ~50% of retail internet access revenue. As such, changes in traffic are expected to have a limited impact on overall network costs. In the context of more efficient (e.g. fiber-based) architectures, costs are even less sensitive to traffic.

We estimate that embedded caching enables ISPs to avoid around USD5 billion per annum in traffic-sensitive costs globally. If ISPs had to rely on IP transit for just 10% of traffic currently exchanged through domestic peering in order to bring content 'on shore', we estimate that ISPs would need to spend a further USD1.4 billion per annum. These two mechanisms result in an estimated USD6.4 billion of savings per annum for ISPs.

Investments made by CAPs act as a substitute for investments that ISPs would otherwise have to make in transport networks, and in delivery networks (i.e. caching). CAP investment helps ISPs to reduce the cost of traffic delivery. By investing in large infrastructure projects like submarine cables to self-supply their connectivity needs, CAPs are also contributing to the overall investment in what was historically pure telecom infrastructure, reducing the need for telecom operators to invest in these systems. The reduction in spend for telecom operators is at least the size of the direct investment that CAPs make in transport networks (USD2.2 billion per annum in the period 2018–21).

Furthermore, by using their global scale to deliver traffic broadly in dozens or hundreds of IXPs and other peering locations across the world, CAPs are reducing the need for ISPs to purchase transit or connect internationally to CAP 'home bases' in multiple cities and countries. Finally, CAPs also invest in on-net caches that can be embedded inside ISP networks, either by deploying these caches directly, or by using commercial CDNs. This reduces the backbone and backhaul capacity that ISPs need to provide to deliver a given amount of content to their end users, and further mitigates ISP network investments even as demand continues to grow, both in terms of traffic and quality of experience. Figure 3.4 overleaf illustrates how the cost for ISPs decreases and quality of end-user experience increases as CAPs invest more to bring content closer to end users.

<sup>103</sup> Multi-band antennas allow operators to deploy multiple spectrum bands on a single antenna, or to active new bands supported by the antenna if relevant spectrum is acquired at a later stage. This allows more capacity to be deployed on a single antenna compared to earlier antennas that only supported one band. Network virtualization, which involves replacing some legacy hardware components with software replacements, can further augment this process, by enabling certain upgrades or updates to be made remotely and more efficiently.

<sup>104</sup> 3GPP (2022), *Specifications*. Available at <https://www.3gpp.org/specifications>

<sup>105</sup> Network disaggregation refers to the separation of different parts of traditionally integrated networks, to allow for different components to be provided by different suppliers, which is a departure from traditional integrated solutions provided by large vendors. As long as solutions are interoperable, network disaggregation could allow new vendors to compete in different parts of the network value chain with new hardware or software solutions. An example of a movement toward network disaggregation is the Open radio access network (RAN), which focuses on disaggregating the mobile radio access network to enable more competition and innovation in the value chain. The aim of Open RAN is to deliver better cost efficiency and more flexibility in deploying network functions to suit specific strategies.

<sup>106</sup> Analysys Mason Research (2022), *Open RAN could deliver up to 30% TCO savings for operators with the right platform strategy and skill set*. Available at <https://www.analysismason.com/research/content/perspectives/open-ran-tco-rma18-rma16/>

**FIGURE 3.4:** ROUTES FOR TRAFFIC DELIVERY UNDER DIFFERENT CACHING SCENARIOS FOR A FIXED NETWORK ARCHITECTURE [SOURCE: ANALYSYS MASON, 2022]

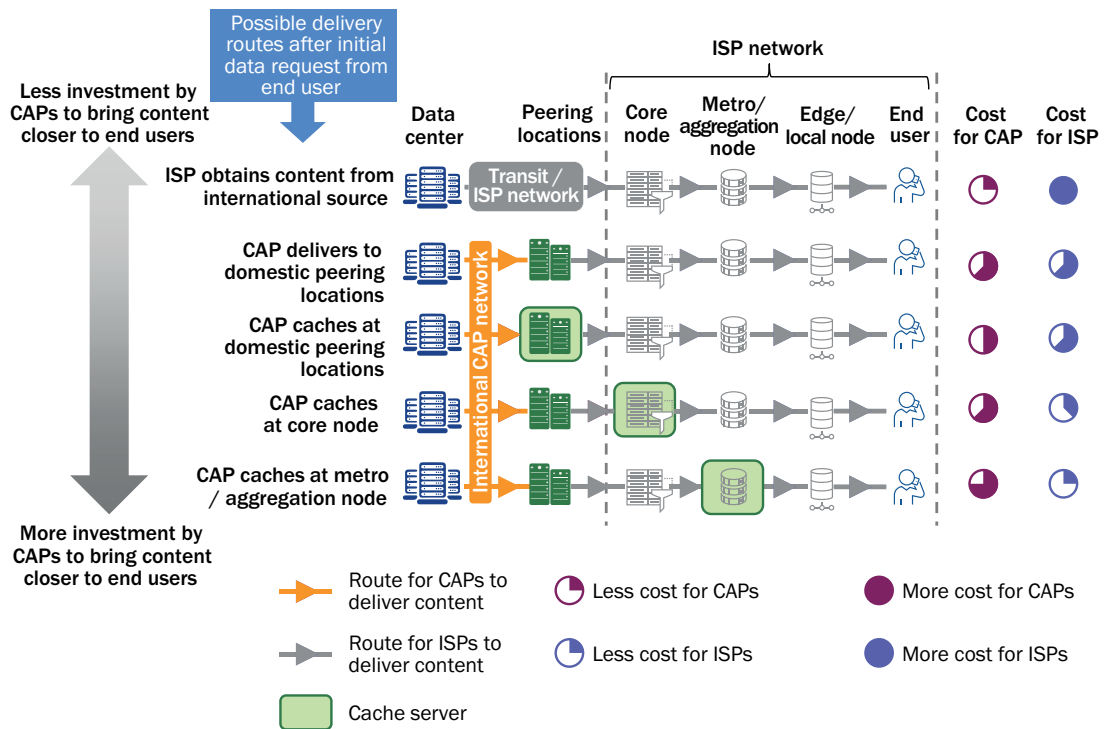

The remainder of this section further explores the impact of CAP investments in delivery networks on ISP costs, and quantifies these impacts based on modeling developed for this study.

To do this, we first establish a 'baseline scenario', which reflects how current networks already benefit from CAP investments, and are also undergoing a transition from legacy copper-based architectures to future-proof fiber-based architectures. This allows us to show the evolution of costs and traffic within this baseline scenario over time, and further illustrate how costs could be even lower as network architectures become more efficient.

Thereafter, we consider a further set of sensitivities to explore how costs would be different if caching was not used. These sensitivities first consider the impact of removing caches that are embedded in ISP networks only, and then consider the impact of removing caches in both ISP networks and at peering locations.

**3.3.1 Core and backhaul costs for fixed ISP networks are estimated to be USD34 billion in 2022 for regions considered,<sup>107</sup> which is ~20% of network costs or ~10% of retail revenue**

As mentioned in Section 3.2, ISP network costs in fixed networks are not very sensitive to changes in traffic: traffic-sensitive costs typically sit in ISP core and backhaul networks and make up a small share of total costs. Furthermore, the deployment of caches by CAPs at interconnection points or within ISP networks is already helping to manage cost levels.

Figure 3.5 below shows core and backhaul costs in a baseline scenario representing the current situation, where caches are already being deployed at interconnection points and are embedded within many

ISP networks. We recognize that ISPs are in the middle of a transition to fiber, which affects the topology / architecture of their networks. This transition is currently driven through incumbents performing network upgrades, as well as a growing number of alternative network operators (altnets) that are deploying new networks. Together with scale, technology and architecture are the major drivers of the magnitude of network costs and their sensitivity to traffic.

Overall, core and backhaul costs, which are the main traffic-sensitive cost components, represent just ~20% of network costs, and network costs in turn represent ~50% of retail internet access revenue. As such, changes in traffic<sup>108</sup> are expected to have a limited impact on overall network costs.

**FIGURE 3.5:** ESTIMATES OF CORE AND BACKHAUL COSTS FOR ISPs ACROSS MODELED REGIONS IN 2022, AND COMPARISON TO REVENUE AND NETWORK COSTS FOR THE SAME PERIOD [SOURCE: ANALYSYS MASON, 2022]

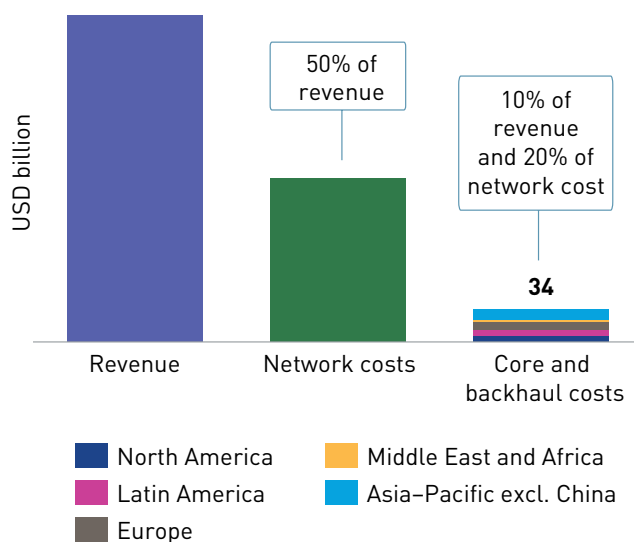

Figure 3.6 overleaf shows the impact of increasing traffic on costs at a particular point in time: we estimate that increasing traffic in a given year by 30%

results in 14% higher core and backhaul costs, but since these are a small part of the total costs, this corresponds to just 3% higher total network costs.

<sup>107</sup> Cost estimates are split into five regions, covering North America, Latin America, Europe, the Middle East and Africa, as well as Asia-Pacific excluding China. China has been excluded as content delivery there is relatively insular – some global CAPs deliver no traffic within China and many China-based CAPs deliver little traffic outside China.

<sup>108</sup> The baseline scenario used in the model reflects historical average busy-hour internet throughput per connection levels by region figures from Analysys Mason Research, as well as traffic growth per connection of 20% per annum.

**FIGURE 3.6:** IMPACT OF INCREASING TRAFFIC IN A GIVEN YEAR BY 30% ON CORE AND BACKHAUL COSTS AND NETWORK COSTS, SHOWN AS A PERCENTAGE OF BASELINE REVENUE [SOURCE: ANALYSYS MASON, 2022]

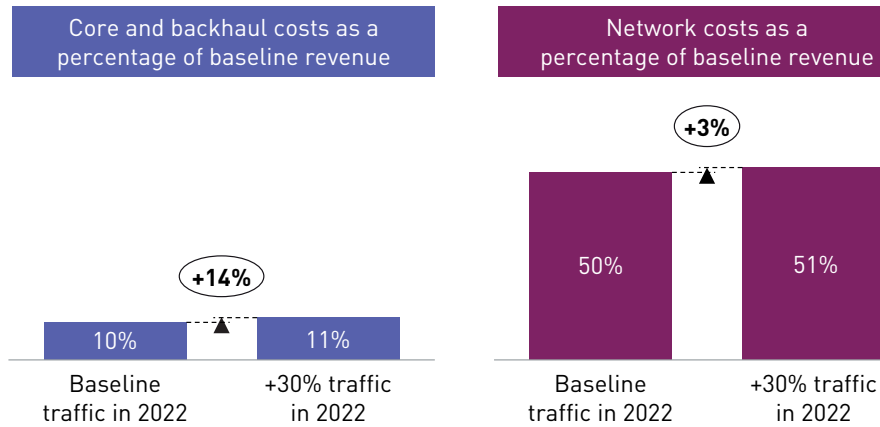

This is consistent with the points raised in Section 3.2: core and backhaul costs in fixed networks are sensitive to traffic, but do not grow in proportion to traffic volumes. Over time, this sensitivity is further eroded by the rapidly decreasing unit cost of equipment: prices for equipment with a given capacity decrease over time,

and new, higher-capacity equipment becomes available at a given price point. Figure 3.7 below shows the result of these dynamics for the next five years: core and backhaul costs in the baseline scenario are expected to increase by only a small amount over time, even as traffic volumes grow more quickly.

**FIGURE 3.7:** EVOLUTION OF MODELED TRAFFIC AND ANNUALIZED CORE AND BACKHAUL COSTS [SOURCE: ANALYSYS MASON, 2022]

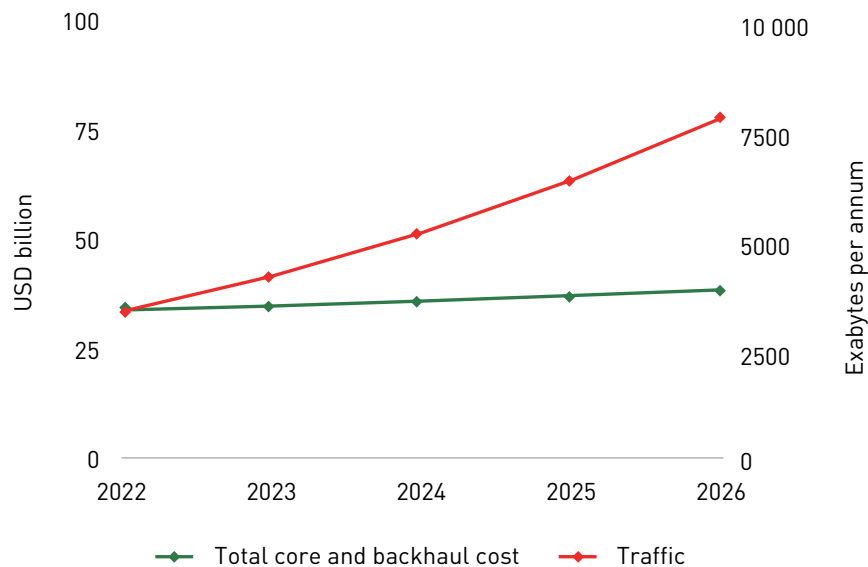

The cost evolution in Figure 3.7 does not account for improvements in the efficiency of network architectures over time. Our analysis suggests that in the context of a more efficient architecture, costs are even less sensitive to traffic. This more efficient architecture reflects the network of many altnets and the target network of many incumbent telecom operators (see Annex C), but we recognize that while some of these more efficient networks are already being deployed, many operators are still undergoing this transition.

Figure 3.8 below shows that traffic-sensitive costs could represent 6.5% of baseline scenario revenue for a more efficient architecture, and 13.5% of baseline scenario revenue for a less efficient, legacy architecture. In practice, the ongoing transition of incumbent networks suggests that the current situation is a hybrid, where we estimate that traffic-sensitive costs represent ~10% of revenue in the baseline case.

**FIGURE 3.8:** IMPACT OF A CHANGE IN THE EFFICIENCY OF MODELED FIXED NETWORK ARCHITECTURE ON CORE AND BACKHAUL COSTS AS A PERCENTAGE OF BASELINE SCENARIO REVENUE IN A GIVEN YEAR [SOURCE: ANALYSYS MASON, 2022]

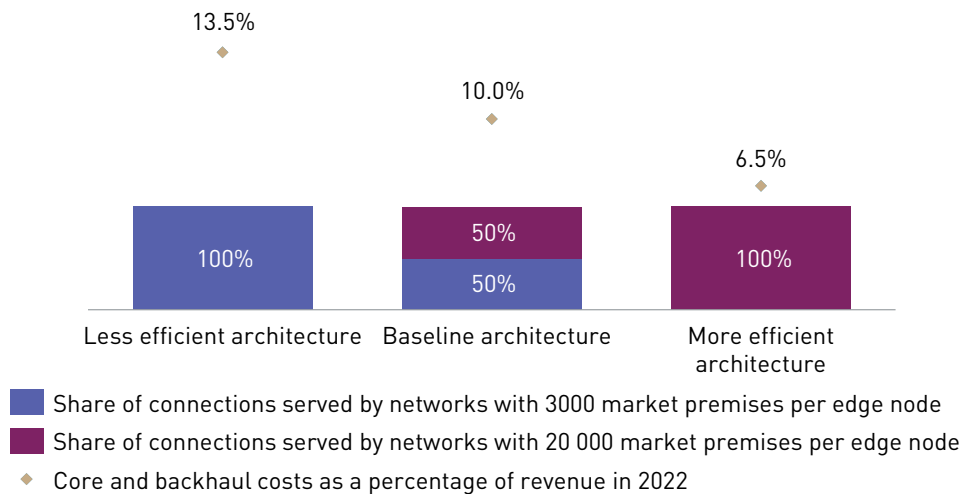

As fixed networks become more efficient over time due to a shift from copper-based to fiber-based architectures, the extent to which total network costs are affected by traffic-sensitive core and backhaul costs will decline. Furthermore, for more efficient architectures, the cost of higher-capacity equipment, and of leased transmission links in competitive markets is eroding rapidly, as a result of economies of scale. These effects would contribute to enabling operators to continue to have relatively stable cost bases despite handling rapidly increasing traffic volumes.<sup>109</sup>

**3.3.2 CAP investments in embedded caching save ISPs USD5 billion per annum, and investments that facilitate peering at domestic peering locations save ISPs further IP interconnection costs**

Current core and backhaul network costs reflect current traffic delivery practices. These include the ability of ISPs to collect traffic through peering links located in their own country, and the use of embedded (on-net) caches located directly in network nodes of the ISP. The use of such embedded caches is widespread, although some ISPs, typically larger incumbent operators with large international carrier businesses, have chosen to collect traffic through peering and transit rather than use these caches.<sup>110</sup>

<sup>109</sup> In a separate piece of work, Analysys Mason explores a potential transition to full fiber in the UK in further detail. See <https://www.analysismason.com/consulting-redirect/reports/netflix-open-connect/>

<sup>110</sup> This is the case in North America, and to a lesser extent in Europe.



On this basis, we estimate that embedded caching enables ISPs to avoid around USD5 billion per annum in traffic-sensitive costs globally. This is likely to be an underestimate of the cost savings ISPs derive, as there is also the widespread availability of domestic peering in their home market to account for, which is enabled by CAP investments in long-distance transport (including submarine cables), and points of presence in both public and private peering locations.

IP transit may not be able to replace the large amounts of peering currently in place, and certainly not at the low prices that are currently available. As such, ISPs may have to operate their own international links to peer remotely, at even higher costs to them. If ISPs had to rely on IP transit for just 10% of traffic currently exchanged through domestic peering in order to bring content 'on shore', we estimate that ISPs would need to spend a further USD1.4 billion per annum. This is shown in Figure 3.9 below.

**FIGURE 3.9:** ESTIMATED CORE AND BACKHAUL NETWORK COSTS IN FIXED NETWORKS IN A GIVEN YEAR, AND INCREASES IN COST NEEDED IN THE ABSENCE OF CAP INVESTMENTS AT DIFFERENT LEVELS [SOURCE: ANALYSYS MASON, 2022]

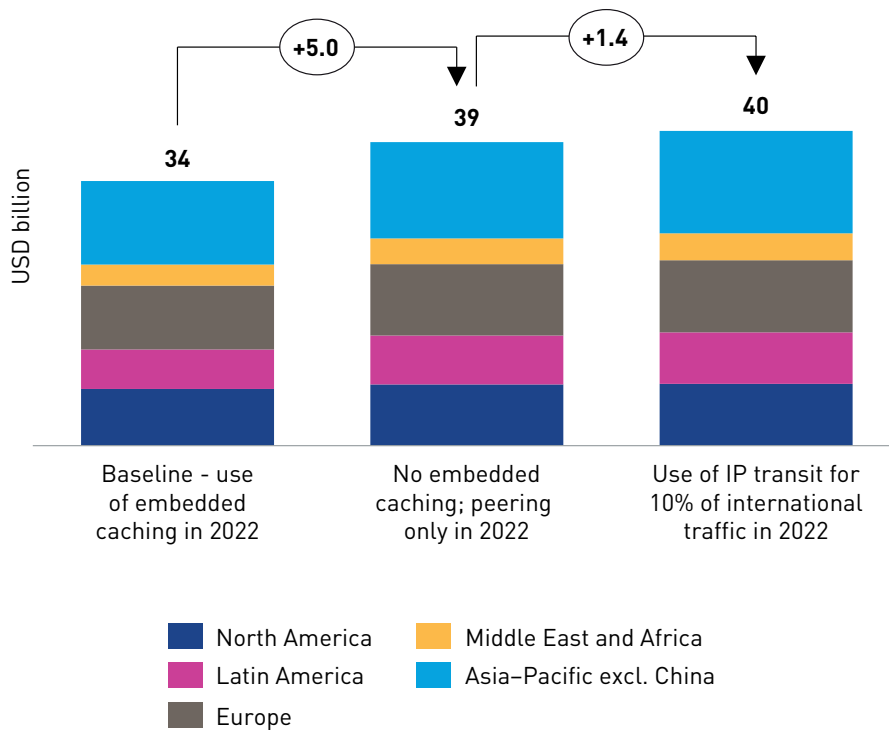

The estimates of core and backhaul costs shown in the figure above reflect regional differences in the number of fixed broadband connections, amount of traffic, estimated link costs for traffic delivery, as well as extent of embedded caching used. As a result of these

different estimates, the calculated amount of savings per connection achieved by ISPs due to the investments made by CAPs in delivery networks also varies by region, as shown in Figure 3.10 below.

**FIGURE 3.10: SAVINGS PER CONNECTION PER ANNUM ACHIEVED BY ISPs DUE TO INVESTMENTS MADE BY CAPs**  
[SOURCE: ANALYSYS MASON, 2022]

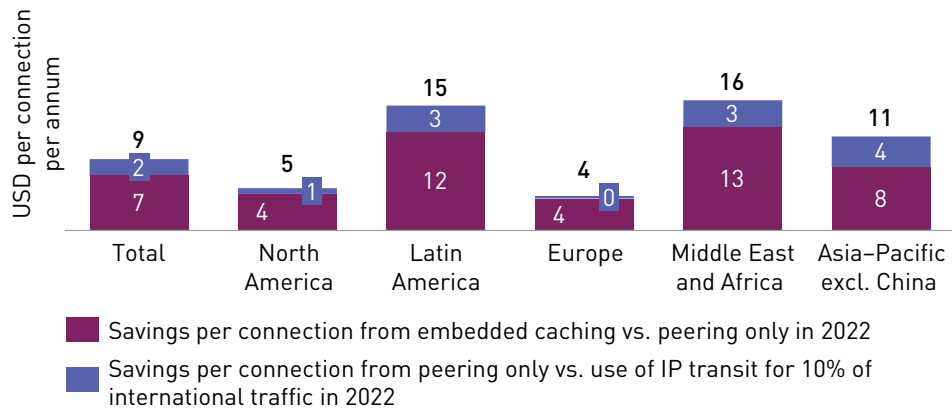

Savings per connection per annum are expected to be lower than average in North America and Europe, but for different reasons. Link costs to deliver traffic across Europe are generally lower than in North America (thanks to much greater average population density and greater competitive intensity in European ISP markets compared to those in North America); however, caching is also more prevalent in Europe, resulting in comparable savings per connection in Europe and North America. Meanwhile, Latin America, the Middle East and Africa, and Asia-Pacific excluding China all exhibit higher-than-average savings per

connection, as connectivity and IP transit costs are materially higher in many places.

As shown in Figure 3.11 below, Asia-Pacific excluding China accounts for the largest share of total savings across both scenarios shown, driven by the number of connections in this region, link and IP transit cost profiles, and expected use of caching. Meanwhile, North America is expected to account for the smallest share of savings, as caching is not as extensive within the region compared to other regions, in spite of the large base of internet users in the region.

**FIGURE 3.11: SPLIT OF ESTIMATED SAVINGS FOR ISP NETWORKS FROM CAP INVESTMENTS IN DELIVERY, BY REGION**  
[SOURCE: ANALYSYS MASON, 2022]

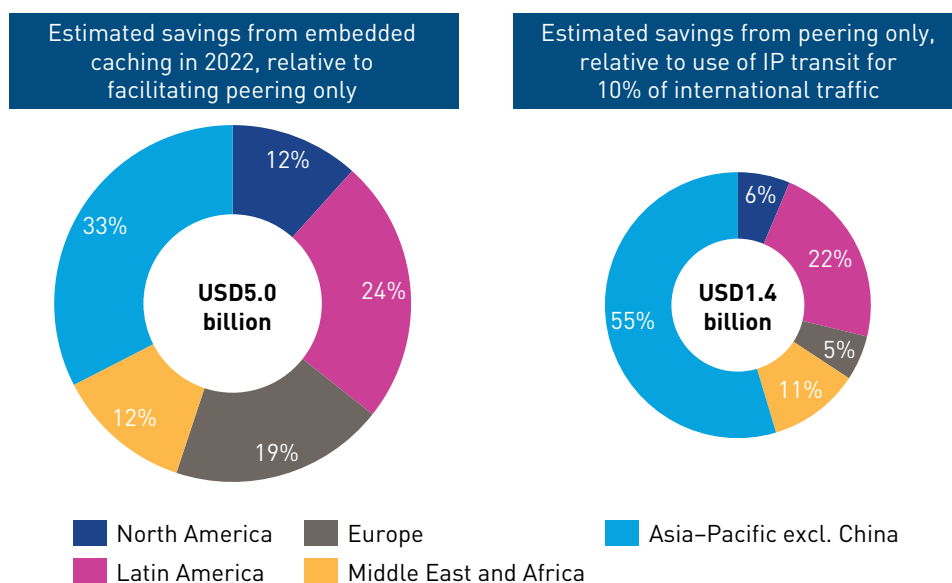

In conclusion, significant growth in traffic volumes over the past few years has primarily been driven by growth in end-user demand for both broadband and online services. This growth in traffic has not been accompanied by corresponding increases in network costs, as traffic-sensitive costs account for a small share of network costs, and these traffic-sensitive costs also do not scale proportionally with traffic. Furthermore, both ISPs and CAPs engage in separate but complementary efforts that help to manage network costs more efficiently over time.

Some proponents of network usage fees suggest that traffic 'driven' by CAPs is responsible for broadband network costs. However, this characterization does not adequately capture the relationship between end-user choice and demand for broadband and online services, and also does not account for the ongoing evolution in network investment and efficiency.

The next section of this report delves deeper into other topics raised in the context of the network usage fee debate and considers other unintended consequences that might arise due to network usage fee implementation.

## 4 When evaluating network usage fees, policy makers should consider regulatory objectives holistically and scrutinize arguments made in favor of their implementation

The internet has developed and grown significantly over the past few decades, driven by collaboration between stakeholders through voluntarily negotiated interconnection agreements. CAPs, ISPs, and other entities participating in the internet value chain, have all played a role in enabling these developments. As shown above in Section 2.2, CAPs are investing significant amounts in internet infrastructure. In delivery networks, CAPs and ISPs have made mutually beneficial strides to deliver increasingly sophisticated content and applications to end users at scale, with greater efficiency over time.

In spite of these developments, calls have been made in several regions for CAPs to compensate ISPs for traffic delivery, through network usage fees. Proponents of these fees have put forth a range of arguments, from drawing parallels to regulated markets for other telecom services, to asserting the need for these fees in order to finance deployment of next-generation networks.

In Section 4.1, we introduce these proposals, summarize key similarities between these calls across various jurisdictions, and highlight how arguments in support of such fees have been made in a way that do not consider a holistic range of regulatory concerns, and should be scrutinized further.

In Section 4.2, we use a qualitative impact model to assess the potential effects of network usage fees through the lens of topics that are of concern to regulators, such as the potential complexity of introducing regulation and alignment with existing regulatory principles; the impact on incentives, competition, and investment for key stakeholders in the market; as well as consequences for residential and business end users, and broader economic growth.

Finally, in Section 4.3, we consider the arguments made in favor of network usage fees that range from drawing parallels with other regulated telecom services to supporting the mission of accelerating

broadband deployment, and conclude that these do not stand up to scrutiny.

### 4.1 Calls for network usage fees have emerged in a few regions, and have largely focused on infrastructure deployment, while avoiding other topics such as competition

#### Highlights

Interconnection has evolved to support sustained and rapid growth in usage of the internet, with competitive prices, high-quality delivery, and the emergence of a wide range of new and innovative services. Despite this success, there have been periodic calls for mandated and regulated changes to the relationship between networks on the internet, in the form of network usage fees to be paid from CAPs to ISPs.

Proposals have largely avoided exploring the impact of these fees on other regulatory considerations, such as competition, and impact on quality of experience for users. When considered holistically, implementation of these fees would ultimately result in negative outcomes for various stakeholders.



In Section 2.1 of this report, we discuss how interconnection between networks on the internet has evolved, from the original small number of academic and research networks to the huge mesh of interconnected networks and peering relationships that are prevalent today. This evolution has supported sustained and exponential growth in usage of the internet, with competitive prices, high-quality delivery, and the emergence of a wide range of new, innovative, and sometimes life-changing services, given how important internet connectivity has proven to be since the start of the Covid-19 crisis.

Despite this success, there have been periodic calls for mandated and regulated changes to the relationship between networks on the internet. In South Korea, legislation has been in place since 2016 to force local ISPs to pay each other for the carriage of internet content to their end users, which has given more (and potentially excessive) leverage to ISPs to demand payments from local operating CAPs. Although litigation and potential legislation are underway in South Korea concerning the extent to which some foreign CAPs must pay ISPs, stakeholders in regions including Europe and the US are themselves calling for

the imposition of traffic-dependent payments from CAPs to ISPs. Proponents of network usage fees tend to mention the growth in video traffic as a driver of costs, but this could be equally applicable to large file downloads, cloud services, gaming, and new applications including the metaverse, which may emerge in the coming years. If such traffic-related network usage fees are imposed, policy makers likely would regulate these mandated fees, replacing the current commercially negotiated arrangements.<sup>111,112</sup>

The main arguments for network usage fees, by region, are shown in Figure 4.1 below.

**FIGURE 4.1: DIFFERENT REGIONAL AREAS OF FOCUS IN PROPOSALS SUPPORTING NETWORK USAGE FEES**  
[SOURCE: SOURCE: ANALYSYS MASON BASED ON PROPOSALS, 2022]

Country	Description
	<ul style="list-style-type: none"> <li>• The largest incumbent telecom operators, grouped under the European Telecom Network Operators (ETNO) umbrella, published a paper written by Axon Partners in 2022</li> <li>• The paper advocated transfer payments between large CAPs and ISPs to help accelerate the deployment of next-generation networks that can meet deployment targets set out in Europe's Digital Decade plan, through FTTH and 5G</li> </ul>
	<ul style="list-style-type: none"> <li>• Larger ISPs under the USTelecom umbrella have made statements suggesting that CAPs should pay directly into the Universal Service Fund (USF)</li> <li>• Arguments are made in support of 'fair cost recovery' of the costs of rural broadband providers, particularly for middle-mile costs, and for CAPs to contribute to ISPs for traffic costs on ISP networks</li> </ul>
	<ul style="list-style-type: none"> <li>• Proposals for bills to impose network usage fees on content providers sending traffic to ISPs</li> <li>• Netflix is facing a court case from SK Broadband to recover costs, with the success and usage of hit Korean show Squid Game, shown on Netflix, helping ISPs make their case</li> </ul>

There are similarities in the calls for action in the three regions. All the proposals that have been made involve a regulated mandate to transfer funds from CAPs to ISPs, in the interest of providing ISPs with additional resources for investment in network infrastructure.

The broad recommendation is to implement something similar to a calling-party-pays (CPP) model used in telephony, in which the network of the caller pays a fee to the network of the called party for terminating the call. In the context of internet traffic, this scheme is

sometimes referred to as a sending-party-network-pays (SPNP) model, and it has already been implemented between domestic ISPs in South Korea. Proposals argue that this is justified as internet traffic delivery can be seen as a 'two-sided' market where ISPs manage pricing on both sides (by sitting between CAPs and end users), to maximize the size of the market.

These calls for network usage fees have been made within a policy and regulatory context that has emphasized investment in digital infrastructure, and

<sup>111</sup> Axon Partners (2022), *Europe's internet ecosystem: socio-economic benefits of a fairer balance between tech giants and telecom operators*. Available at <https://etno.eu/downloads/reports/europes%20internet%20ecosystem.%20socio-economic%20benefits%20of%20a%20fairer%20balance%20between%20tech%20giants%20and%20telecom%20operators%20by%20axon%20for%20etno.pdf>

<sup>112</sup> Forbes (2022), *Should 23 million South Koreans pay more for broadband when only 5 million view Netflix?*. Available at <https://www.forbes.com/sites/roslynlayton/2022/02/23/should-23-million-south-koreans-pay-more-for-broadband-when-only-5-million-view-netflix/?sh=2058094c1013>

with suggestions that CAPs are not making 'fair' contributions to infrastructure. In Sections 2 and 3, we have shown that CAPs are making significant investments in internet infrastructure, which helps to drive improvements in service quality while also mitigating costs for ISPs. Although arguments made in favor of network usage fees appear to be in line with some regulatory priorities, such as expanding access to broadband,<sup>113</sup> proposals have largely avoided exploring the impact of these fees on other topics such as competition and impact on end-user experience.<sup>114</sup>

In Section 4.2, we take a step back to consider regulators' and policy makers' objectives holistically, and show how the implementation of network usage fees would ultimately result in negative outcomes for various stakeholders, for instance, by negatively affecting incentives for CAPs to continue making investments in internet infrastructure, and by introducing incentives that could reduce competition in ISP markets, in addition to other unintended consequences.

Thereafter, we scrutinize arguments made in support of network usage fees in Section 4.3, and show that analogies drawn between internet interconnection and other telecom settings are not appropriate, while the purported benefit of using these fees to accelerate broadband deployment might not necessarily materialize, and instead lead to other connectivity issues.

#### 4.2 Mandated traffic-related fees could have a detrimental impact on stakeholders across the internet ecosystem, which should be concerning to regulators

##### Highlights

Under the current, commercially negotiated regime, both ISPs and CAPs are incentivized to be efficient, resulting in investments that reduce costs and improve the quality of experience for end users. Mandatory network usage fees would make the internet more fragmented, and less resilient and scalable than it is today, due to disincentives to invest in content, infrastructure, networks, and quality of experience.

Network usage fees would have an asymmetric impact and would be detrimental for most stakeholders, as only large ISPs have clear

incentives to call for their introduction. These fees, if implemented, would reduce the ability and incentive for CAPs to invest in infrastructure that brings content closer to end users, as well as in content and services, while also potentially leading to a lower level of competition in the ISP market due to a shift in the competitive balance. For smaller CAPs, network usage fee costs could be prohibitive and may prevent them from entering the market and offering services; it is also possible that a larger ISP could effectively squeeze a smaller ISP in order to take more business. The impact on the internet ecosystem could lead to an even larger effect on the pace of digitalization and economic growth, thus impacting the domestic economy.

Setting network usage fees at the 'right' level, and in an appropriate manner, would be challenging. ISP would have an incentive to set a high network usage fee, because it would be paid by the CAP, and thus would not directly impact the ISP's own pricing. This can lead to market failures, including excessive prices and reduced competition; for example, regulatory intervention to set termination rates was required in some telephony markets using the CPP regime.

There is uncertainty regarding whether network usage fees would be imposed or not and, if they are imposed, how they would be established, or at what level. The review in this section will attempt to highlight several possible effects, to inform decisions by policy makers on whether to implement proposals. Telecom regulators have a broad range of services and topics under their purview. For the purposes of this report, we identify typical objectives for regulators that could be relevant to the network usage fee debate, and classify them into three broad groups:

- the potential complexity of new regulation and alignment with existing regulatory principles
- the impact of regulation on market incentives, competition, and investment
- the resulting effects on consumer welfare and economic growth.

First, regulators would consider the potential complexity of the regulation of network usage fees, in

<sup>113</sup> It should be noted that the private and public sectors continue to channel significant amounts of funding toward fiber deployment, as discussed in Section 3.3 of the report, and described further in Annex D.

<sup>114</sup> For example, in the European context see <https://www.telecomtv.com/content/policy-and-regulation/pushback-big-telco-wants-to-ease-telecoms-regulation-ecta-doesn-t-16490/>

terms of defining an imposition that would be effective, would not incur significant regulatory cost, and that would not contradict existing regulatory principles. If the implementation of network usage fees could pose a challenge for regulators, then there should be detailed consideration of whether the effects of these fees might justify the cost of regulation.

Generally speaking, regulators and policy makers also try to ensure that there are positive incentives for investment in digital infrastructure, which should span both CAPs and ISPs. There should also be efficient competitive dynamics and signals, so that new players can enter the market and invest where incumbents do not. In the particular context of internet interconnection, it is important to note that the current practice of commercially negotiated interconnection incentivizes investments that not only reduce costs, but also result in better quality of experience for end users, whereas regulated network usage fees or other regulated paid interconnection fees would necessarily disrupt these arrangements to the detriment of end users.

For end users, there are two immediate relevant factors – the price of the service and the quality of the service experience. That is the case for online services such as video streaming and gaming, and for broadband (or ISP) access. While end users may pay separate prices for an online (CAP) service and ISP service, both may be impacted by network usage fees. Quality of experience is a result of CAP investments, and these investments are likely to decrease with network usage fees, resulting in a lower quality of experience for end users. While it may be difficult for end users to determine whom to blame when there is latency or poor resolution of their video or gaming streams, end users will be negatively impacted. Consequently, the overall ecosystem also will be negatively impacted due to lower levels of consumer welfare, including the take-up of CAP and ISP services. The broader economic growth that results from the adoption of online services and broadband also could be negatively affected. Accordingly, the potential adverse effects of network usage fees could extend well beyond the CAP, ISP, and telecom sectors.

Figure 4.2 overleaf provides an overview of the impact that network usage fees could have on various stakeholders in a domestic market.

#### 4.2.1 Policy makers would have to consider the potential complexity of defining an appropriate method of imposing these fees, and the regulatory burden that could be introduced

From a regulatory perspective, there are a number of complexities that need to be addressed before implementing network usage fees, and regulators would need to make a significant effort to impose paid interconnection regulations in this otherwise unregulated space. The first consideration is the nature of the imposition. Should the regulator impose a mandate to negotiate a rate, or should it directly impose the rate, as is often the case with other regulated rates? If the latter, how should rates be set, and what is the cost to the regulator?

Beyond the nature of the imposition, it would also be challenging to decide to which entities the rate should be applied. Proposals that aim to target specific entities – ETNO refers to 'tech giants' – could be discriminatory, and go against established net-neutrality rules, which would further complicate the potential implementation of these fees. How is a 'tech giant' defined? And what if the traffic is distributed across multiple CDNs – would they be charged based on the identity of their CAP client, or only based on the amount of traffic they are delivering?

The challenges of imposing network usage fees will arise regardless of the recipient of the fees. Specifically, in the US there is an argument that network usage fees be paid into an expanded Universal Service Fund, in order to help subsidize the costs of ISPs in high-cost regions.<sup>115</sup> This would highlight some of the fundamental challenges of imposing network usage fees. Would a CAP be charged for sending downloads (such as a software upgrade or movie) to users during off-peak hours when there is little traffic? Would anyone be charged for peer-to-peer (P2P) traffic that does not originate from a CAP but uses capacity, and if so how would it be measured and who would be charged?

Imposing network usage fees would be a costly, time-consuming exercise, and would be a large step back from the demonstrated results of voluntarily negotiated interconnection that has characterized the internet since its commercial beginnings.

<sup>115</sup> Federal Communications Commission (2022), *FCC Reports to Congress on Future of the Universal Service Fund*. Available at <https://www.fcc.gov/document/fcc-reports-congress-future-universal-service-fund>

**FIGURE 4.2:** IMPACT OF NETWORK USAGE FEES ON VARIOUS STAKEHOLDERS [SOURCE: ANALYSYS MASON, 2022]

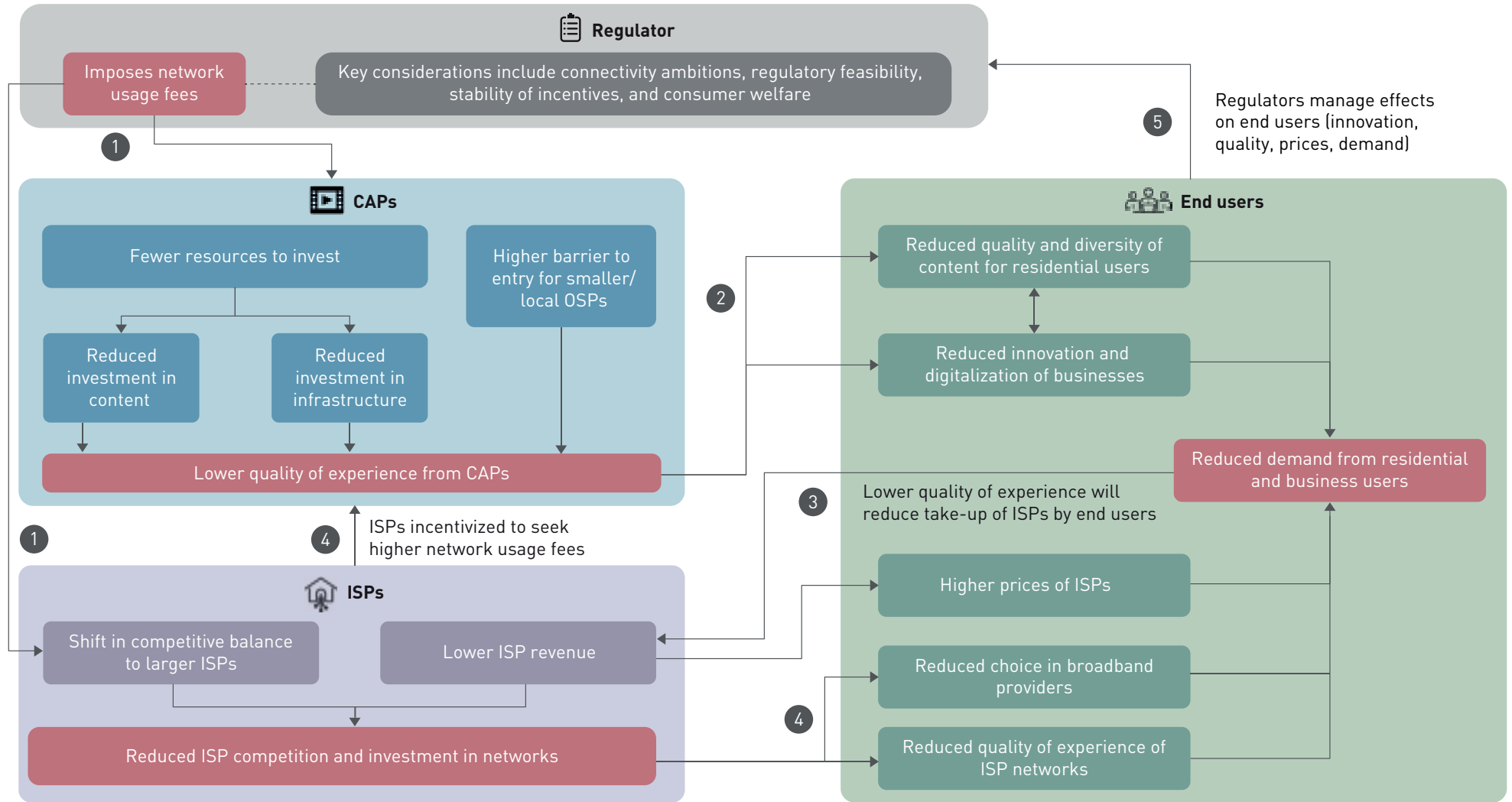



*A network usage fee would enable ISPs to fully express the termination monopoly they have over delivering traffic to their subscribers, requiring complex, long-lasting regulatory oversight*

Introducing mandated traffic-dependent fees results in the exercise of a 'termination monopoly', because the ISP would be the only way for the streaming service to reach its subscribers. As a result, the ISP would have an incentive to set a high network usage fee, because it would be paid by the CAP, and thus would not directly impact the ISP's users. This is a market failure that has often arisen in telephony, and resulted in regulatory intervention on the setting of termination rates. There are already examples of disputes arising from large ISPs exercising the termination monopoly. In Germany, for instance, Deutsche Telekom (DT) does not peer with content providers, and instead requires them to pay for transit to deliver content to its end users.<sup>116</sup>

In telephony, for historical reasons, many interconnection arrangements were structured as CPP, where the calling party would pay a wholesale fee to terminate a call on the called party's network. This termination monopoly was regulated from the outset on fixed networks, but when mobile networks developed, they were typically free to set termination rates as they wished. This led to extremely high termination prices, which resulted in distortions in the retail price of calls made on-net versus calls across networks. This brought about issues on the wholesale termination market (supernormal profits) but also distortion in competition on retail markets. It also led to transfers between (regulated) fixed operators and (unregulated) mobile operators.

In other markets, including the US and in some ways Singapore and Hong Kong, 'bill and keep' became the norm, whereby retail charges cover all the costs of the network to which a customer is connected. This resulted in more efficient competition in retail markets, including large any-network bundles and much lighter regulation – a similar situation as is prevalent on the internet today.

Higher calling rates in CPP markets lowered call volumes, and the distortions had to be corrected through extensive and enduring regulatory intervention.<sup>117</sup> Moving towards a CPP-like SPNP model

for internet interconnection is likely to result in extensive and long-lasting regulation that regulators have spent the last 20 years unwinding in telephony markets. ISPs would have an incentive to set high network usage fees, both to raise revenue and, where relevant, also to discriminate in favor of their own competing services, including (today) their own streaming and pay-TV services.

Setting network usage fees at the 'right' level would be challenging. Fundamentally, it would require regulators to take a view on the costs that network usage fees would need to help ISPs recover. If they are traffic-sensitive costs, marginal and incremental costs would represent a relatively small share of ISPs' revenue. If they go beyond that to cover access network costs, there would not be a clear cost-causation mechanism, and regulators would need to police the use of these funds, in order to ensure that funds are used only to finance access networks that otherwise would not be deployed without network usage fees.

In South Korea, regulating domestic network usage fees then also extended to regulating quality of service, an additional regulatory burden and a variation on how internet interconnection arrangements elsewhere have enabled higher-quality interconnections without regulation. This is discussed further in Section 4.3.2.

*Some proposals suggest regulating only specific large CAPs; however, this raises net-neutrality concerns, and could also impact smaller companies that are dependent on cloud services*

Beyond deciding how the fees should be imposed, policy makers would also need to decide whether the fees should be applied uniformly, or if they should apply only to certain companies. Applying fees uniformly could have particularly detrimental effects on smaller companies (as discussed further in Section 4.2.1). Some of the current proposals for network usage fees explicitly target CAPs above a certain size. However, targeting some CAPs based on size, and not others, would be discriminatory, and could violate the spirit of net-neutrality regulations, if not the letter.

Concerns about net neutrality have already been raised in certain jurisdictions. For example, in July 2022, 54 members of the European Parliament wrote a letter to

<sup>116</sup> See WIK-Consult (2022), *Competitive conditions on transit and peering markets*. Available at [https://www.bundesnetzagentur.de/EN/Areas/Telecommunications/Companies/Digitisation/Peering/download.pdf?\\_\\_blob=publicationFile&v=1](https://www.bundesnetzagentur.de/EN/Areas/Telecommunications/Companies/Digitisation/Peering/download.pdf?__blob=publicationFile&v=1)

<sup>117</sup> Analysys Mason advised the UK communications regulator, Ofcom, on this topic during a market review in 1998, and has since then advised many other regulators.

the European Commission to express their concerns about how the potential introduction of network usage fees could work against net-neutrality guarantees in the region.<sup>118</sup> This follows calls by digital rights activists in the region that were made a month prior on the same topic.<sup>119</sup>

Furthermore, it is possible that trying to target specific large CAPs would be ineffective in any case, because of how many smaller companies are customers of large public cloud providers and CDNs. If these cloud and CDN providers have to pay network usage fees, they could then pass costs on to smaller cloud-enabled CAPs, rendering moot the attempt to charge only large CAPs and penalizing success and growth, for both large and small CAPs.

#### **4.2.2 Network usage fees, if introduced, would distort incentives in the market for CAPs and ISPs and thus affect investment, leaving the market ecosystem in a poorer state**

The introduction of network usage fees would affect the incentives for both CAPs and ISPs in a way that eventually results in less competition and adverse impacts on consumer welfare. Larger CAPs would have less incentive to continue making investments to bring content closer to end users, and smaller CAPs would face higher barriers to entry. Meanwhile, network usage fees could benefit larger ISPs more than smaller ISPs and lead to a lower level of competition in the ISP market due to a shift in the competitive balance.

When considering the interconnection ecosystem as a whole, network usage fees would effectively slow or reverse some of the advances described in Section 2.1, by moving the market away from peering and caching, and back towards transit. Smaller CAPs may avoid delivering traffic directly to ISPs, in order to avoid network usage fees, leaving ISPs to use resources to gather content, potentially in another country. As a result, smaller ISPs in particular would be more reliant on purchasing transit than larger vertically integrated counterparts, and end-user quality of experience may suffer from the lack of a direct connection closer to the ISP. Companies that purchase transit have much less control over whether end-user quality improves over time. The introduction of network usage fees would

therefore move the ecosystem from one that incentivizes investments that improve quality, to one that does not.

The intrinsic link between demand for online services and broadband services suggests that these effects on CAPs and ISPs could reinforce one another over time, and result in further disincentives to invest in content, infrastructure, networks, and quality for end users.

*Network usage fees would reduce the quality and diversity of content offered by CAPs, and could reduce the level of competition between ISPs and therefore their incentives to invest*

Network usage fees would reduce the ability of CAPs to invest in infrastructure, as well as content and services,<sup>120</sup> unless CAPs can recover these fees through higher prices, which would reduce their subscriber base and further reduce resources available to invest elsewhere. Either way, end users would suffer from higher prices or from lower-quality online services. Importantly, because ISPs are arguing that these fees are necessary to make their investments viable, it is fair to assume that there would not be a corresponding decrease in broadband prices.

In addition, implementation of network usage fees could also increase barriers to entry for smaller CAPs. Larger CAPs have been building their own cloud or CDN infrastructure, and they benefit from economies of scale in delivery, due to a global presence that allows them to peer with many ISPs directly. Smaller CAPs typically have to pay CDN or cloud costs to deliver traffic, and do not enjoy significant economies of scale. The additional network usage fee costs could be prohibitive for entering and offering services.<sup>121</sup>

The network usage fee could also impact competition between ISPs, particularly by raising costs or entry barriers for smaller ISPs. First, it is possible that a larger ISP can effectively squeeze a smaller one in order to take more business.<sup>122</sup> For instance, a negotiation over network usage fees can raise costs for a smaller ISP and/or lower the quality for the smaller ISP if the larger one refuses to upgrade peering connections. This can result in the content customers of a smaller ISP moving to the larger ISP to avoid the

<sup>118</sup> See <https://arstechnica.com/tech-policy/2022/07/eu-lawmakers-slam-idea-of-forcing-big-tech-to-pay-for-isps-network-upgrades/>

<sup>119</sup> See <https://www.reuters.com/technology/making-big-tech-share-telecoms-costs-would-undermine-eu-net-neutrality-rights-2022-06-07/>

<sup>120</sup> Each year, CAPs, including the largest streaming video providers, spend over USD120 billion on internet infrastructure, as discussed in Section 2; in addition, they are spending tens of billions of dollars per annum on developing or acquiring content to attract and retain users.

<sup>121</sup> Some network usage fee proposals aim to focus on large CAPs, meaning that the effect mentioned here might be less relevant; however, such proposals might be challenged as being discriminatory.

<sup>122</sup> In 2012, the Autorité de la concurrence in France noted, in the context of a dispute between France Télécom and Cogent, that although the request from France Télécom to charge a fee for opening additional interconnection capacity was consistent with its peering policy, there was a lack of transparency between the domestic network (Orange) and the transit operator business (Open Transit) that had the potential to facilitate a margin squeeze. For more, see <https://www.autoritedelaconcurrence.fr/en/communiqués-de-presse/20-septembre-2012-internet-traffic-peering-agreements>

costs or improve the quality of service and experience. An example of this situation was seen in Switzerland, where Swisscom asked for a renewed interconnection contract with higher prices from a smaller ISP, Init7, which resulted in at least one CAP transit customer of Init7 moving to Swisscom. The Swiss Federal Administrative Court ruled in favor of Init7, stating that Swisscom exploited its dominant position in peering.<sup>123</sup>

Even when the content provider is not a customer of the smaller ISP, there can be an impact. Given the economies of scale of directly peering or placing a cache with an ISP, the economics of placing a CDN cache with a smaller ISP may be overrun by network usage fees. As a result, the smaller ISP may need to use transit connections to connect with a CDN cache, possibly in another country, for each video stream, rather than have the content delivered to it more efficiently and with better quality through a cache. This would significantly raise the cost for smaller ISPs, in comparison with larger ISPs that may still benefit from a cache and receive network usage fees. This would decrease the level of competition between ISPs in a country and lower the incentive to invest.

The impact of a network usage fee on CAPs, namely fewer resources to invest in content and network infrastructure, can in turn impact ISP revenue: lower quality of experience and poorer content reduce the value of the internet for end users and would reduce users' willingness to pay for broadband. This would have a knock-on effect on ISP revenue, and further incentivize ISPs to try and seek higher network usage fees.

*Forcing a shift away from commercially negotiated interconnection and toward a regulated scheme would lead to poorer incentives for stakeholders to continually improve quality for end users*

Under the current, commercially negotiated regime, the mode of interconnection and traffic delivery, its costs, and the resulting quality of experience, can be balanced and optimized by CAPs and ISPs in partnership, as both are incentivized to be efficient. For instance, instead of network usage fees, today an ISP can condition its peering policy to interconnection in multiple points in its networks (e.g. major cities or

regions). The CAP or CDN can respond to these policies by expanding its network, including negotiating with the ISP to place caches inside the ISP's network, which would improve the quality of experience for end users, while also lowering costs for the ISP.

However, if network usage fees are mandated, this dynamic will be altered. Depending at which point the network usage fees are charged, and how they are set, ISPs may have an incentive to maximize the traffic that is subject to network usage fees, and therefore may refuse to allow caches in their networks. This would result in artificial loading on parts of the network that may not need to be used if caches were deployed. There may also be less incentive for a CAP or a CDN to invest in bringing its traffic closer to the ISP's network, given that it is paying for delivery in any event. Network usage fees may also reduce the resources available to CAPs and CDNs to deploy network infrastructure,<sup>124</sup> both in terms of caching, as well as peering.

If network usage fees cause incentives to shift in the way described above, then the market on the whole is likely to rely more heavily on transit than it currently does – this would affect costs as well as quality of experience. Although transit prices are low in some regions, they are currently higher in others. Transit prices typically exhibit a significant year-on-year decline; however a shift to network usage fees could disrupt this decrease in prices (as is happening in South Korea, and described further in Section 4.3.2). In such a case, costs for stakeholders in the ecosystem (i.e. CAPs, ISPs) may remain higher than either a scenario where transit prices continue to fall, or where the use of peering and caching reduces costs, as done in many regions at present. We note that this issue would likely occur irrespective of whether traffic-related fees are paid directly to ISPs, or into a separate fund, because it is the mandate to make payments based on traffic volumes that would influence CAPs' incentives to invest.

It is also likely that network usage fees might curtail the ability of CAPs to continue choosing their own approach to traffic delivery, and the incentives of ISPs to develop innovative approaches. For instance, CAPs and ISPs may not be able to benefit from Open Caching, which would enable ISPs to deploy their own

<sup>123</sup> The Swiss competition authority found that Swisscom exploited its dominant position in peering. Swisscom had tried to ask for a renewed interconnection contract with higher prices from Init7, which resulted in a dispute between the operators. For more, see [https://www.bundesnetzagentur.de/EN/Areas/Telecommunications/Companies/Digitisation/Peering/download.pdf?\\_\\_blob=publicationFile&v=1](https://www.bundesnetzagentur.de/EN/Areas/Telecommunications/Companies/Digitisation/Peering/download.pdf?__blob=publicationFile&v=1) and [https://berec.europa.eu/eng/document\\_register/subject\\_matter/berec/download/0/7092-draft-berec-report-on-ip-interconnection\\_0.pdf](https://berec.europa.eu/eng/document_register/subject_matter/berec/download/0/7092-draft-berec-report-on-ip-interconnection_0.pdf)

<sup>124</sup> We note that although ETNO members seem to be arguing that network usage fees could be levied on specific large content providers, in practice they would not be able to differentiate between content providers when traffic goes through a CDN (including the cloud CDNs used by many broadcasters) and smaller content providers. As a result, the fees may be imposed on the CDN, impacting all its customers, small and large.

CDNs that host content from multiple CAPs, and receive payment from the CAPs for use of those CDNs.<sup>125</sup> For CAPs, this could be one of several approaches used to optimize traffic delivery within a competitive market environment, and prices that ISPs would charge would be constrained by the other CDN options available to CAPs. With network usage fees, ISPs may have less incentive to deploy open caches, and CAPs may not be willing to 'double pay' ISPs to deliver their content. Organic innovation and collaboration between stakeholders has driven the efficient development of the internet for decades without the need for regulation, and the introduction of network usage fees would disrupt this dynamic.

#### **4.2.3 Implementing network usage fees could result in quality-of-service issues in the short term, and affect ongoing consumer welfare and broader economic growth in the longer term**

The previous sub-sections within Section 4.2 have established that implementing network usage fees could be challenging from a regulatory perspective, and could distort incentives for CAPs and ISPs. Ultimately, such developments would affect end users. This final sub-section explains how the act of regulation itself could present quality-of-experience issues, while distorted incentives for CAPs and ISPs could not only affect end-user welfare in terms of quality or pricing, but could also result in less choice for business users, as well as slower growth for local companies and economies.

*The process of implementing network usage fees itself could result in quality-of-experience issues*

If the selected network usage fee approach involves mandated negotiation, then there could be a detrimental effect on quality of experience as part of the negotiation process. One example of the result of a mandated negotiation is the retransmission of broadcast stations by pay-TV operators in the US. Under regulations, the pay-TV provider must carry a broadcast signal, but without any fees. The broadcast station is not obliged to make its channel available for must-carry,<sup>126</sup> however, can provide retransmission consent to the pay-TV provider for a fee or other concession. Should the parties not reach agreement, there could be a blackout, prompted by either side, to

create pressure for a deal. In such a situation, a station is not available over a pay-TV service for a period of time, resulting in frustrated subscribers.

A blackout is only feasible on the internet today if a CAP decides to pull its services out of a country in response to mandatory network usage fees. While this is possible, a more likely outcome would be a rupture in service quality: some content providers would have an incentive to minimize or avoid paying the network usage fee, for example by not interconnecting directly with the ISP and making its content available only through transit connections. This could result in higher latency, more congestion, lower resilience, and higher costs for ISPs that would have to collect traffic in a different country. Other content providers, in particular smaller ones or those with a significant share of their business in a country where network usage fees are imposed, would not have this option: they would have to pay ISPs or face a degradation of the service they offer end users. Whichever way this plays out, consumers are likely to suffer a deterioration in quality or an increase in costs.

More broadly, the requirement to establish commercial paid agreements with each ISP will result in a reduction in the number of peering arrangements between networks, given that 99.9% of arrangements today are on an informal or 'handshake' basis. Mandatory network usage fees will make the internet more fragmented, and less resilient and scalable than it is today.

*Consumer welfare would suffer as a consequence of implementing network usage fees, and the growth of domestic businesses could also be affected, impacting the economy more broadly*

The impact of network usage fees on the incentives for CAPs and ISPs, as described in Section 4.2.1, would eventually be felt by end users in the form of higher prices and/or lower quality of experience. The potential for these fees to impact smaller CAPs and ISPs more dramatically compared to their larger counterparts suggests that domestic industry development could also be hindered.

Should network usage fees be implemented, CAP profits, and therefore resources to invest, would be

<sup>125</sup> See Annex B for more details.

<sup>126</sup> Refers to the requirement for traditional TV platforms (e.g. cable) to carry public broadcast channels.

affected. For end users, this reduces the diversity and amount of content, as well as the quality of experience provided; the price of an online service subscription, for instance, could also increase. The effect that these fees could have on the ISP market, in terms of shifting the competitive balance to larger ISPs and reducing competition in the market, could result in detrimental effects on end users as well, in terms of reduced choice, less price competition, and slower network investment.

As established in Section 3.1, the demand for online services and the demand for broadband are inherently linked, and therefore the impact of introducing network usage fees on both CAPs and ISPs and the resulting effects on end users could be long-lasting.

In terms of domestic industry development, the barriers to entry that smaller CAPs would face as a result of these fees, as well as the potential for larger ISPs to gain further competitive advantage over smaller ISPs, could hinder the rate at which local CAPs or ISPs grow over time. This could have an even larger effect on the domestic economy when considering that consumption of increasingly sophisticated online services and broadband by other businesses is typically expected to accelerate the pace of digitalization and economic growth.

#### **4.3 Calls for the regulation of traffic-related fees paid by CAPs to ISPs are not well substantiated, and these fees are unlikely to deliver the envisioned benefits**

##### **Highlights**

Most of the traffic delivered over the internet is content requested by users, at a quality level that the users themselves are asking for. The delivery of traffic is effectively a one-sided market – the price set by ISPs only impacts the number of broadband subscribers and their usage.

Ongoing investments in broadband infrastructure are already being made through funding from various sources. In the context of network usage fees, ISPs could end up receiving more funding than necessary for deployments, particularly since current proposals do not set out appropriate conditions to ensure that funds are only used for necessary deployments.

In South Korea, network usage fees are disrupting interconnection and traffic delivery, and have led to higher-than-expected transit costs and greater average latency, ultimately resulting in higher costs and lower quality of experience for end users.

The network usage fee proposals described in Section 4.1 differ slightly across regions but have several common themes that are considered in this sub-section. In Section 4.3.1, we evaluate two common underlying premises that these proposals rely on to argue in favor of network usage fees. In Section 4.3.2, we consider two examples of how these proposals cite potential connectivity outcomes as justifications for network usage fees, and how these envisioned outcomes might not necessarily be achieved even if these fees are implemented.

#### **4.3.1 Some of the proposals for network usage fees rely on characterizations of internet interconnection and the market for traffic delivery that are inaccurate**

There are two main characterizations that proposals make in support of network usage fees. First, proposals largely call for fees to be transferred from CAPs to ISPs on the basis of traffic for internet interconnection, using mechanisms that are similar to how voice interconnection is regulated. Second, some proposals also suggest that this is justified as the delivery of internet traffic should be seen as a two-sided market, with ISPs serving as a platform that sits between CAPs and end users, and helping to manage pricing on both sides to maximize the size of the market. Below, we show how these two characterizations are not adequately supported.

*Voluntary interconnection agreements for internet traffic do not tally with the regulation of voice service interconnection, because the underlying premise for internet traffic differs from that for voice services*

The characterization of traffic as being generated by CAPs and thus justifying transfers of fees between CAPs to ISPs is inherently flawed. The CPP regulations introduced in Section 2.1 have long been used for international calls between historical monopoly public operators, between the fixed incumbent and domestic entrants when competition was introduced, and between competing mobile operators. There is one common thread for all types of voice calls using CPP arrangements: it is easy to identify the party that originated the call, and then include in the cost of the call the termination rate to be paid to the operator of the called party.

This property of voice calls does not hold for internet services, as it is often hard to unambiguously identify the originator of a stream of traffic. Was a video stream pushed out by an advertiser, for instance, or was it pulled in by a viewer? In practice, even this distinction is weak: end users consume advertising together with the content they want, in exchange for this content being lower cost or free. Thus, the implication that the traffic is 'caused by' the CAP that should therefore pay for it does not hold. Most of the traffic delivered over the internet is content requested by users, at a quality level that the users themselves are asking for. For example, high-definition (HD) or ultra-high-definition (UHD) videos are streamed either on the request of the end user, or because online streaming services use adaptive algorithms to modulate the quality (and bitrate) of streaming content to use less capacity when the network is busier, or when the receiving device can support such a resolution. CAPs have no incentive to send video to a device at a higher resolution than it is possible for the device to display.<sup>127</sup>

As a result, and contrary to what some proponents of network usage fees have argued,<sup>128</sup> applying SPNP to internet traffic will not send proper price signals. The content provider is delivering traffic requested by the user, at a quality that is expected by the user, with

limited control on the user request. And therefore the higher price paid by the content provider would not send a signal upon which the content provider could act. The broadband user, on the other hand, could act upon price signals, for instance by lowering requested resolution or downloading video at off-peak times. Some broadband providers have already incorporated price signals by tiering the bandwidth offered or capping monthly downloads. However, increased broadband prices have been expressly taken off the table by ETNO, and implicitly by others pushing for network usage fees in their place.

*An ISP's delivery of traffic to end users is not a two-sided market*

For a market to be two-sided, both sides need to interact through a platform, with the adoption and usage on one side increasing the benefits on the other side of the platform (this is also known as indirect network effects).<sup>129</sup> As a result, two-sided strategies involve the platform using pricing on each side of the market to impact the outcome. Platforms thrive online. For instance, Airbnb is a classic platform – renters are looking for a wide variety of properties, and owners are looking for a large base of renters. Airbnb manages the pricing on both sides to maximize the market size, with no explicit fee for renters and commissions only when a rental is paid.

With regard to networks, however, a foundational characteristic of the internet is that any service available to one ISP in a country is available to all ISPs.<sup>130</sup> The service can be made available directly through peering, or without peering, indirectly through transit. Under net-neutrality principles and regulations,<sup>131</sup> an ISP cannot block a legally available service (as a core principle of internet access, now enshrined in all net-neutrality regulations) and has no incentive to block popular services in any case. This means that lowering the price of broadband may attract more users, but all existing online services would already be available to the users, and this would not change. Conversely, raising broadband prices will not change the availability of online services – they will be accessible through any ISP whose users subscribe

<sup>127</sup> For instance, see <https://www.cloudflare.com/en-gb/learning/video/what-is-adaptive-bitrate-streaming/>

<sup>128</sup> Layton, R.; Potgieter, P. (2021), *Rural broadband and the unrecovered cost of streaming video entertainment*. Retrieved from <https://www.econstor.eu/bitstream/10419/238035/1/Layton-Potgieter.pdf>

<sup>129</sup> See, for instance, Rochet, J.-C. and Tirole, J. (2003), *Platform Competition in Two-Sided Markets*, *Journal of the European Economic Association*, 1 June 2003.

<sup>130</sup> Some CAPs may not hold rights to any content in a given region, in which case they are still typically accessible through a web browser, but do not offer a service.

<sup>131</sup> Such as the EU's OpenInternet Regulations, for example.

to the service.<sup>132</sup> The result is that the delivery of traffic by ISPs is effectively a one-sided market – the price set by ISPs only impacts the number of broadband subscribers and their usage.

It is worth considering that if the delivery of traffic by ISPs was actually a two-sided market, ISPs might have to pay to attract popular online services and content, in the same way that pay-TV operators pay for premium content and channels. In addition, ISPs could begin to bid to gain exclusive access to popular services, such as streaming providers offering premium movies or sporting events, in order to increase their number of end users. This would fracture the any-to-any principles of the internet, enshrined in net-neutrality regulations, and demonstrates further how and why ISPs are not platforms in a two-sided market.

On the other hand, CAPs do benefit from an increased number of broadband subscribers, which represent their addressable market, and also benefit from ensuring high-quality connections for good viewing. This relationship has played a driving role in all of the commercial changes in interconnection arrangements described above. To address the cost of delivering bandwidth-intensive content such as high-quality video, content providers have invested to deliver requested content closer to the ISPs' end users to reduce ISPs' costs, which also improves quality of experience. The lower costs can translate into lower ISP prices, increasing the number of subscribers, and the improved quality of experience can increase usage for the ISPs.

#### **4.3.2 Network usage fees would not necessarily result in the envisioned benefit of accelerating network deployment, and could be detrimental for connectivity in other ways**

Network usage fee proponents tend to suggest that these proposals would allow countries to achieve better connectivity. In Europe, operators are arguing that funds raised through the implementation of these fees would enable ISPs to accelerate deployment of

broadband networks. Meanwhile, South Korea is used as an example of a country that has performed well under certain measures of connectivity, and that has implemented fees on domestic ISPs/CAPs; however, as we discussed above, transit costs are rising in South Korea and fiber network deployment was attained prior to the introduction of fees. Although these arguments are presented as being in line with the concerns of regulators, network usage fees, if implemented, are unlikely to result in the connectivity benefits envisioned.

*Fixed broadband networks, particularly in Europe, continue to see healthy investment from various sources, while 5G investment, though ongoing, remains constrained by concerns over future demand*

In the Axon paper prepared for ETNO,<sup>133</sup> it was argued that payments from large CAPs to ISPs would help accelerate the deployment of FTTP and 5G, to help meet deployment targets in Europe's Digital Decade plan. However, ongoing investments in broadband infrastructure are already being made through funding from various sources, available now or in the near future. These are detailed further in Annex D.

It should be noted that even if network usage fees are implemented, these fees are likely to only come into effect in several years' time, once a large share of investment in these networks would already have been made. Given the abundance of funding that is already committed from various sources to FTTP deployments, it is possible that ISPs could end up receiving more funding than necessary for deployments. Accordingly, policy makers would need to consider the appropriate conditions to ensure that funds are only used for necessary deployments and that funds are not distributed as increased profits to shareholders.

More recently, it also appears that the significant demand for roll-out has caused supply chains to be stretched, and in conjunction with recent external pressures on the supply chain, is leading to a situation where additional funding might not be able to

<sup>132</sup> In some cases ISPs may block access to specific content – this tends to be limited to illegal content, including sexual abuse of minors (and gambling and pornography in some countries), and to apply at the level of a country, not an individual ISP.

<sup>133</sup> Axon Partners (2022), *Europe's internet ecosystem: socio-economic benefits of a fairer balance between tech giants and telecom operators*. Available at <https://etno.eu/downloads/reports/europes%20internet%20ecosystem.%20socio-economic%20benefits%20of%20a%20fairer%20balance%20between%20tech%20giants%20and%20telecom%20operators%20by%20axon%20for%20etno.pdf>

accelerate roll-out further. For example, in the UK, investors are continuing to provide funding to altnets and fiber deployment platforms, while raw material cost increases and labor shortages are constraining roll-out.<sup>134</sup>

Regardless of the timing of these flows of funds to ISPs, the arguments in favor of network usage fees do not address the fact that ISPs may not have the incentive to spend these fees on additional infrastructure, preferring instead to increase profits.<sup>135</sup> Furthermore, current proposals on network usage fees have not elaborated on any potential mechanisms for ensuring that these fees, once received by ISPs, would be put toward meaningful additional network investments that help to improve connectivity and user experience instead of other uses.

For mobile networks, network usage fees, if implemented, are also unlikely to have a significant impact. The upgrade of mobile networks to 5G is ongoing, and high-traffic areas are being upgraded first to unlock the benefits of new spectrum and more efficient technology, as discussed in Section 3.2. An ongoing barrier to faster and deeper deployment of 5G relates to uncertainty about additional revenue opportunities from new services, and uncertain returns on investment outside of high-traffic areas. While operators report interest in using 5G to differentiate its offerings, a 'killer app' for 5G has yet to be uncovered, and many potential opportunities lie in enterprise markets (which tend to have diversified and fragmented requirements, and reduced economies of scale).<sup>136</sup>

There may be an important policy question here as to whether policy makers should be pushing for 5G investment without clear demand, but regardless of the answer, network usage fees would not provide a better economic case. Traffic-dependent network usage fees for mobile would mainly be generated in urban, traffic-sensitive areas, which have already been identified by mobile operators as priority areas for 5G upgrades. In other, less traffic-sensitive areas, traffic levels are low, and the commercial use case for new 5G

applications is still developing, meaning that network usage fees would generate only small amounts of payments in these areas, and would be unlikely to be able to substantially improve the business case for 5G deployment in any case.

*Recent developments in South Korean connectivity, following the introduction of network usage fees, suggest that other countries could also be negatively impacted if they implement a similar scheme*

The situation in South Korea has been used to support arguments in favor of network usage fees, with the country often characterized as being a global leader in broadband,<sup>137</sup> in order to justify following its example. While South Korea has made broadband widely available, this had largely taken place before the introduction of new fees for domestic ISPs and CAPs. Further, more recent developments in the evolution of connectivity in South Korea, since the introduction of network usage fees, would suggest that the introduction of these fees could result in undesirable outcomes for other countries as well.

Several potential effects laid out in Section 4.2 appear to have developed in South Korea. Since the introduction of network usage fees for CAPs in South Korea, incentives for CAP investment in the country have been disrupted, leading to a shift away from localization of delivery (i.e. through peering or caching) and toward international transit, an additional regulatory burden related to quality of experience, a fall in the competitiveness of domestic CAPs due to higher transit costs, and also a lower quality of experience for end users on multiple dimensions.

When Meta allegedly shifted some of its traffic from South Korea to be picked up in Hong Kong,<sup>138</sup> the regulator imposed a fine against Meta for restricting users' access to services. Meta successfully contested this before the District and High Courts and this is pending before the Supreme Court. In turn, a new regulation was introduced to require certain high-traffic-generating content providers to make sure their services remain 'stable' in a country.<sup>139</sup>

<sup>134</sup> Financial Times (2022), *UK 'altnets' risk digging themselves into a hole*. Available at <https://www.ft.com/content/e630a3a1-03ac-4526-83ac-16ff851067cc>

<sup>135</sup> See for example Williamson, B., Communication Chambers (2022), *An internet traffic tax would harm Europe's digital transformation*. Available at <https://lisboncouncil.net/wp-content/uploads/2022/07/COMMUNICATIONS-CHAMBERS-Internet-Traffic-Tax-2.pdf>

<sup>136</sup> Analysys Mason Research (2021), *The impact of new applications on 5G RAN strategies*. Available at <https://www.analysismason.com/research/content/reports/5g-ran-strategies-rma18/>

<sup>137</sup> For example, see <https://strandconsult.dk/netflix-v-sk-broadband-the-david-and-goliath-battle-or-broadband-fair-cost-recovery-in-south-korea/>

<sup>138</sup> The Korean Herald (2019), *Facebook, Naver join forces in criticizing network usage fee regulations*. Available at <http://www.koreaherald.com/view.php?ud=20190827000844>

<sup>139</sup> For a history of the issues, see Internet Society (2022), *Internet Impact Brief: South Korea's Interconnection Rules*. Available at <https://www.internetsociety.org/resources/doc/2022/internet-impact-brief-south-koreas-interconnection-rules/>



This demonstrates how the setting of network usage fees in South Korea had led to an additional regulatory burden in terms of the regulation of end users' quality of experience.

The introduction of these fees has also affected the cost of transit in South Korea, in turn leading to negative consequences for smaller domestic CAPs. The cost of transit in many countries typically has been declining over time, and the investments made by CAPs to improve international connectivity have an impact on transit prices. For example, in Australia, IP transit prices fell significantly following the announcement of several submarine cable systems in the early 2010s, including INDIGO, in which Google had invested.<sup>140</sup> Asian countries reportedly have seen declines of roughly 20% per annum. However, in South Korea the added costs imposed by network usage fees has led to the evolution of transit costs diverging from other countries in the region. As a result, Korean CAPs have found it challenging to host content domestically due to higher costs and have either moved overseas or have become less competitive.<sup>141</sup>

The introduction of network usage fees has also had a negative impact on end-user experience. According to a report published by the Organization for Economic Co-operation and Development (OECD) in July 2022,<sup>142</sup> overall average latency experienced by users in South Korea (as measured towards Cloudflare's CDN) is the highest among OECD countries. The report notes that this result may be due to a majority of measurements for South Korea being taken from foreign points of presence, which have a higher average latency measurement than local points of presence. Importantly, the introduction of network usage fees could disincentivize CAPs or CDNs from deploying points of presence domestically. This may lead to latency being higher than in a scenario where network usage fees are not introduced and more domestic points of presence are deployed. Ultimately, such higher latency would adversely impact consumer welfare. For example, Amazon-owned Twitch announced in July 2022 that it would begin trialing the use of a P2P mechanism to deliver content in

South Korea due to rising costs associated with network usage fees, and on its own website, disclosed that this will cause viewers to experience an increase in latency.<sup>143</sup> Twitch also suggested that users who opt into P2P could experience a potential loss of privacy, and stated that if users prefer to maintain privacy, they might have to sacrifice video quality. This demonstrates how network usage fees could negatively affect multiple dimensions of customer experience.

A study for the German regulator BNetzA was produced by WIK-Consult and published earlier in 2022, and also documents these effects, including a withdrawal of CAPs from the South Korean market, a decline in the diversity of online content, as well as expectations of rising prices for end users, reduced infrastructure investments, and ultimately, a lower quality of experience for end users in the market.<sup>144</sup>

As the situation in South Korea continues to develop, the examples presented above highlight how network usage fees are disrupting interconnection and traffic delivery in the country, ultimately resulting in higher costs and lower quality of experience for end users.

<sup>140</sup> See <https://www.analysismason.com/contentassets/b8e0ea70205243c6ad4084a6d81a8aa8/australia-country-chapter.pdf>

<sup>141</sup> See <https://carnegieendowment.org/2021/08/17/afterword-korea-s-challenge-to-standard-internet-interconnection-model-pub-85166>

<sup>142</sup> OECD (2022). *Broadband networks of the future*. Available at <https://www.oecd-ilibrary.org/docserver/755e2d0c-en.pdf?expires=1659966485&id=id&accname=guest&checksum=85B0F3FB66FF03752FF4111E10BF8E51>

<sup>143</sup> Twitch. Korea P2P Test FAQ. Available at [https://help.twitch.tv/s/article/p2p-faq?language=en\\_US](https://help.twitch.tv/s/article/p2p-faq?language=en_US)

<sup>144</sup> WIK-Consult (2022). *Competitive conditions on transit and peering markets*. Available at [https://www.bundesnetzagentur.de/EN/Areas/Telecommunications/Companies/Digitisation/Peering/download.pdf;jsessionid=4F82FD1F00D8D8D2DA9A50CE6BCDBAED?\\_\\_blob=publicationFile&v=1](https://www.bundesnetzagentur.de/EN/Areas/Telecommunications/Companies/Digitisation/Peering/download.pdf;jsessionid=4F82FD1F00D8D8D2DA9A50CE6BCDBAED?__blob=publicationFile&v=1)

## 5 Implementing network usage fees could disrupt existing arrangements and reverse gains made in connectivity to date

Since its inception, the internet has evolved and grown through the collaborative efforts of various stakeholders, each playing an important role in the continued delivery of new and improved content and applications to end users, helping to unlock fresh opportunities for billions across the globe. In terms of the technical architecture and infrastructure supporting the internet, growth has been made possible by players up and down the value chain continuing to engage in voluntary negotiations that result in mutually beneficial agreements. These agreements have largely been made in the context of competitive markets, free of regulation, and continue to evolve based on the changing requirements of stakeholders in the value chain, in the ongoing quest to deliver improvements to end users.

Recent calls for CAPs to compensate ISPs for the carriage of traffic have been made in several regions. Thus far, these proposals have focused on the potential impact on ISP profits and returns, but not yet on the internet ecosystem as a whole. Some of these calls either explicitly or implicitly frame the discussion as one that pits CAPs against ISPs and ignore the fact that ongoing collaboration between CAPs and ISPs has been key to the growth of the internet and is fundamentally driven by the link in demand for online services and demand for broadband. CAPs continue to invest significant amounts in internet infrastructure that enable improved service delivery to end users and that also provide cost savings to ISPs. Both CAPs and ISPs are operating in a dynamic interconnection environment, with each having a variety of commercial options in order to optimize service delivery and compete in their respective markets.

The prospect of implementing traffic-dependent network usage fees appears inadvisable at present. Current calls for mandated fees do not accurately identify the true determinants of traffic delivery, are likely to result in effects to the internet ecosystem that would be harmful for multiple stakeholders, and are based on arguments that falter under scrutiny.

- Proponents of network usage fees tend to suggest that traffic delivery has a larger impact on network costs than they actually do. In reality, the volumes of traffic demanded by end users have grown significantly over the past few years, while network costs have remained relatively stable. These arguments also tend to characterize traffic as being driven by CAPs, ignoring the fact that it is ultimately the choices made by end users that determine traffic volumes, and that, as mentioned above, the demand for online services and broadband are inherently linked.
- The act of regulating interconnection by imposing traffic-dependent, required fees would also result in unintended consequences that regulators are likely to find problematic. These fees would have a detrimental impact on incentives for CAPs and ISPs, which would affect ongoing investment in quality and cost control and would also lead to reduced competition between ISPs and higher barriers to entry for smaller CAPs, thus limiting the amount of choice available to consumers in the market.
- Mandated network usage fees would potentially fragment the global internet end-user experience today. If a CAP (or anyone who uploads something onto the internet) has to reach an agreement with each and every ISP in the world for that traffic to reach end users, then many companies will be forced to serve only a handful of geographical markets, or maybe even only their own domestic market. Consequently, end users would have fewer choices, and receive a lower quality of experience and less value for money. When considering the impact of poorer connectivity on business end users, this could also lead to slower digitalization and economic growth. Defining a suitable regulatory approach would also be challenging and would result in a material regulatory burden.

- The arguments made by proponents of these fees to justify implementation also do not stand up to scrutiny. Analogies drawn with other telecom services, such as voice services and services delivered through two-sided markets, are not suitable when considering differences between internet interconnection and those other examples. Suggestions that network usage fees could accelerate broadband deployment have also been made using flawed arguments. In Europe, for example, significant amounts of funding from both the public and private sector are already flowing into broadband deployment. The same is happening in the US. Network usage fees, even if mandated, would only become relevant after a significant amount of deployment has taken place. Pointing to South Korea as an example of a country with high broadband availability that has implemented network usage fees is also misleading. Network usage fees were introduced in South Korea after deployment had largely occurred, and the introduction of these fees has more recently led to other detrimental effects on connectivity in that country that are a clear warning sign.

The arguments made as part of calls for network usage fees thus far are not well substantiated and would suggest a fundamental shift away from the nature of voluntary collaboration that has underpinned the success of the internet, with potentially detrimental effects. Any significant regulatory intervention would need to be based on fact and evidence, and be proportionate to any substantiated (and not alleged) market failure it seeks to correct, paying close attention to potential unintended consequences and the cost of regulation itself.

## Annex A Background on interconnection on the internet and in traditional telecom services

### A.1 More background on peering and transit

Peering and transit are introduced in Section 2.1 of the main body of the report, and these form the basis for internet interconnection, originally enabling a hierarchy of providers. Peering is a bilateral arrangement, and neither partner would allow traffic from one peering partner to transit its network to another peering partner – those two peering partners would need to establish their own arrangement to exchange traffic. The providers at the top of the hierarchy are known as global Tier 1 backbones. They have full global connectivity based on peering, which they use as an input to sell transit to their customers, without having to purchase transit themselves.

There are several important differences between peering and transit agreements. Peering is historically between similar networks (also known as peers) which co-operate to negotiate agreements, even when they are competing in the same market. The global Tier 1 backbones typically interconnect in multiple locations to exchange traffic in order to roughly balance costs between the distance and volume of traffic that they deliver and receive from their peering partner. The arrangement is mutually beneficial and, to keep it simple, the vast majority of peering arrangements do not involve payments in either direction (also known as settlement-free peering) and do not even have a formal contract.<sup>145</sup>

Transit, on the other hand, typically involves a provider such as a retail ISP or CAP accessing the rest of the internet through a provider with more network coverage and connectivity, including notably the global Tier 1 provider with global connectivity. As such, the smaller provider pays the larger network for access.

As the internet developed and spread within and across countries, IXPs emerged to enable providers to exchange traffic with one another through a shared public switch. Large backbones are able to balance traffic loads by meeting in multiple IXPs, and to exchange traffic with their regional or local transit

customers. IXPs also serve to 'democratize' peering and flatten the hierarchy, by allowing ISPs and CAPs to peer directly with one another rather than using transit, thereby lowering their transit costs. One of the main drivers of IXPs was to enable providers to exchange traffic without using more expensive transit connections that might even leave the region or country to exchange traffic with another ISP in the same region or country.

With regard to the cost of the traffic, early peering arrangements were generally subject to conditions about exchanging traffic in multiple locations in order to ensure a rough balance in the distance and volume of traffic carried between peering partners. However, the increase in video traffic introduced a divide between content providers and their transit providers and end-user ISPs, with the latter noting that they were receiving more traffic than they were sending.

CAPs began to arrange to deliver the content to a peering location closer to the end users, in order to lower the distance of traffic carried by the ISP, and thereby lower their transit costs.

### A.2 More detail on developments in mobile telephony interconnection

Section 4.3.1 in the main body of the report introduces several developments regarding the history of interconnection in telephony markets. This annex sub-section provides further detail on some of the developments mentioned.

In mobile telephony, in countries with CPP arrangements, interconnection between operators was required, but rates could be negotiated. The result was typically above-cost mobile termination rates, because the termination rates were paid by the calling party, and thus had no direct impact on the subscribers of the called party, who set the rates. This led to artificially high termination rates imposed on calls, including from fixed lines, and led to distortions within the mobile markets. Larger mobile operators had an

<sup>145</sup> Packet Clearing House (2021), *2021 Survey of Internet Carrier Interconnection Agreements*. Available at <https://www.pch.net/resources/Papers/peering-survey/PCH-Peering-Survey-2021/PCH-Peering-Survey-2021.pdf>

incentive to make it expensive for customers of other mobile operators to call their subscribers, and offer cheaper on-net calls, as an incentive for customers from smaller networks to switch to their already larger network.

The exception to using CPP for voice calls is instructive for assessing internet interconnection arrangements. Several countries, including the US and Singapore, used mobile party pays (MPP), which was a combination of 'bill and keep' between mobile operators and regulated interconnection charges between fixed and mobile networks.<sup>146</sup> In this arrangement, the calling (mobile) party is billed by their operator for making a call, and the called (mobile) party is billed by their operator for accepting a call, with no interconnection payment. This arrangement requires no regulatory intervention, as no interconnection rate needed to be set, and historically led to greater call volumes, and thus greater utility for consumers, since the price facing the calling party did not include the cost of terminating the call. In the bill-and-keep countries, large bundles of minutes could be offered in subscriptions, from which incoming and outgoing calls could be deducted, and over time many of these became unlimited. This was possible because there were no outgoing charges to pay and was not possible in CPP countries until the regulated termination rates fell significantly.

Bill-and-keep arrangements most closely resemble the common peering arrangements in which one network pays to deliver the traffic to a point, such as an IXP, where the other network picks it up and delivers it to its subscribers with no settlements paid. The success of bill and keep in those countries using it for mobile voice begs the question as to why regulators may want to go in the other direction for internet interconnection.

<sup>146</sup> Ofcom (2008), *Case studies of mobile termination regimes in Canada, Hong Kong, Singapore and the USA*. Available at [https://www.ofcom.org.uk/\\_data/assets/pdf\\_file/0024/47391/annex8\\_1.pdf](https://www.ofcom.org.uk/_data/assets/pdf_file/0024/47391/annex8_1.pdf)

## Annex B Methodology for estimating CAP infrastructure investment, and examples of how investments are evolving

### B.1 Methodology for estimating historical CAP investment in internet infrastructure

The following sub-sections give further detail of the approach used to estimate the level of direct and indirect investment made by CAPs in the hosting, transport, and delivery infrastructure clusters defined in Section 2.2 of the main body of the report.<sup>147</sup>

#### B.1.1 Hosting

The methodology for estimating the level of investment made by CAPs in hosting infrastructure is as follows:

- 1. Assessment of global investment in hosting.**  
 Third-party data and extrapolations from historical assessments by Analysys Mason prior to 2018 on global investments are used to inform total global spend on data-center facilities, servers, and storage devices.
- 2. Total CAP-driven investment in hosting.** This investment is then filtered in order to account for the share spent by CAPs, based on third-party data as well as qualitative assessments following interviews with major CAPs and data-center providers.
- 3. Split of CAP investment into direct and indirect investment.** The global data-center investment directly made by CAPs is informed by the level of infrastructure-related capex reported by major CAPs on internet infrastructure (as a majority of this investment is for hosting). The remaining CAP investment is attributed to indirect spend and is validated using third-party data sources to estimate the percentage of co-location provider spend made on behalf of CAPs. Hosting investments are allocated to different regions in accordance with the growth in regional cloud availability zones for major CAPs and regional hyperscale data-center capacity.

**FIGURE B.1:** MODELING TO ASSESS THE INVESTMENT MADE BY CAPs IN HOSTING INFRASTRUCTURE  
 [SOURCE: ANALYSYS MASON, 2022]

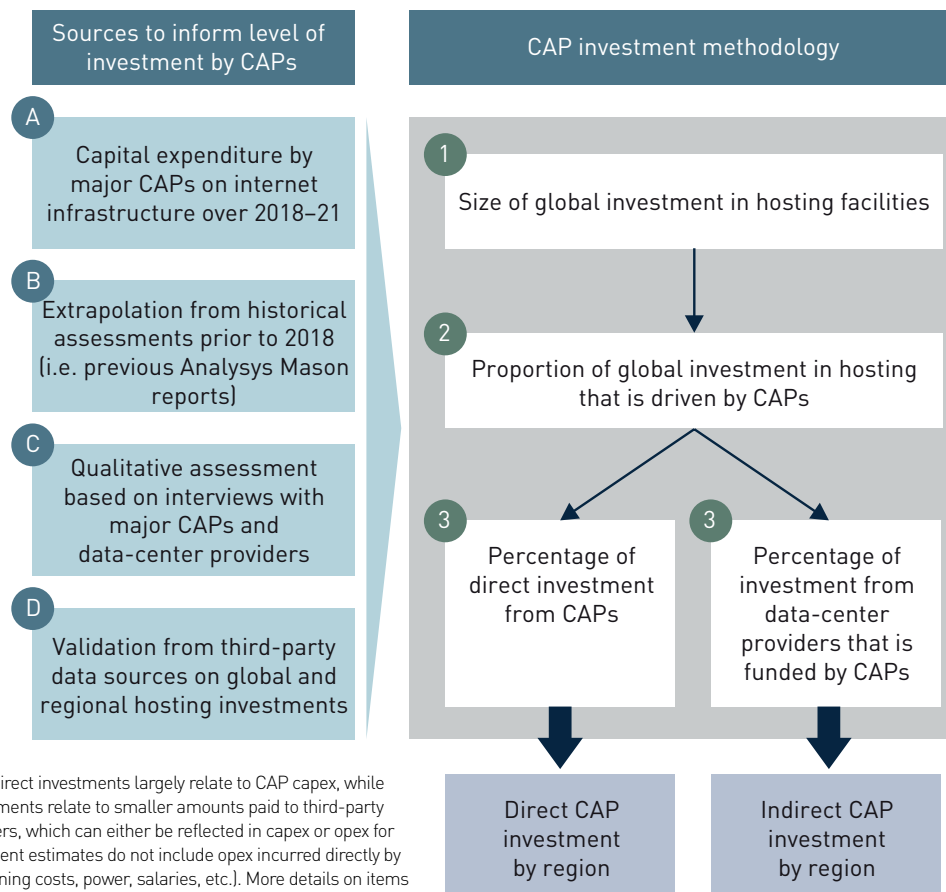

<sup>147</sup> Estimated direct investments largely relate to CAP capex, while indirect investments relate to smaller amounts paid to third-party service providers, which can either be reflected in capex or opex for CAPs; investment estimates do not include opex incurred directly by CAPs (e.g. running costs, power, salaries, etc.). More details on items included in investment estimates can be found in our earlier study from 2014, available at <https://www.analysismason.com/consulting-redirect/reports/content-application-provider-investment/>.

### B.1.2 Transport

The methodology for estimating the level of investment made by CAPs in transport infrastructure (e.g. in submarine and terrestrial cables) follows four main steps:

1. **Total investment for carrying internet traffic on submarine cables.** Third-party data on investments is used to inform total global spend on submarine cables, including recurring maintenance and upgrade capex for older cables. Submarine investments are allocated to different regions based on the proportion of landing points within each region.
2. **CAP-driven investment in submarine cables.** Third-party data is used to estimate the total submarine investment by CAPs based on the share of international traffic driven by content providers.

3. **CAP-driven investment in terrestrial cables.** Terrestrial cable investment has been informed by interviews with major CAPs and backbone providers on the relative spend on terrestrial versus submarine cables, as well as extrapolation from historical assessments by Analysys Mason on terrestrial investments prior to 2018.
4. **Split of CAP investment into direct and indirect investment.** To determine the split of investment made by CAPs in submarine cables into direct and indirect investment, we first consider the investment in cables for which there are CAP investors, based on third-party sources. Indirect investment is calculated as the difference between total and direct investment. Regional splits for terrestrial investments are based on data regarding total fixed and mobile traffic by region.

**FIGURE B.2:** MODELING TO ASSESS THE INVESTMENT MADE BY CAPs IN TRANSPORT  
[SOURCE: ANALYSYS MASON, 2022]

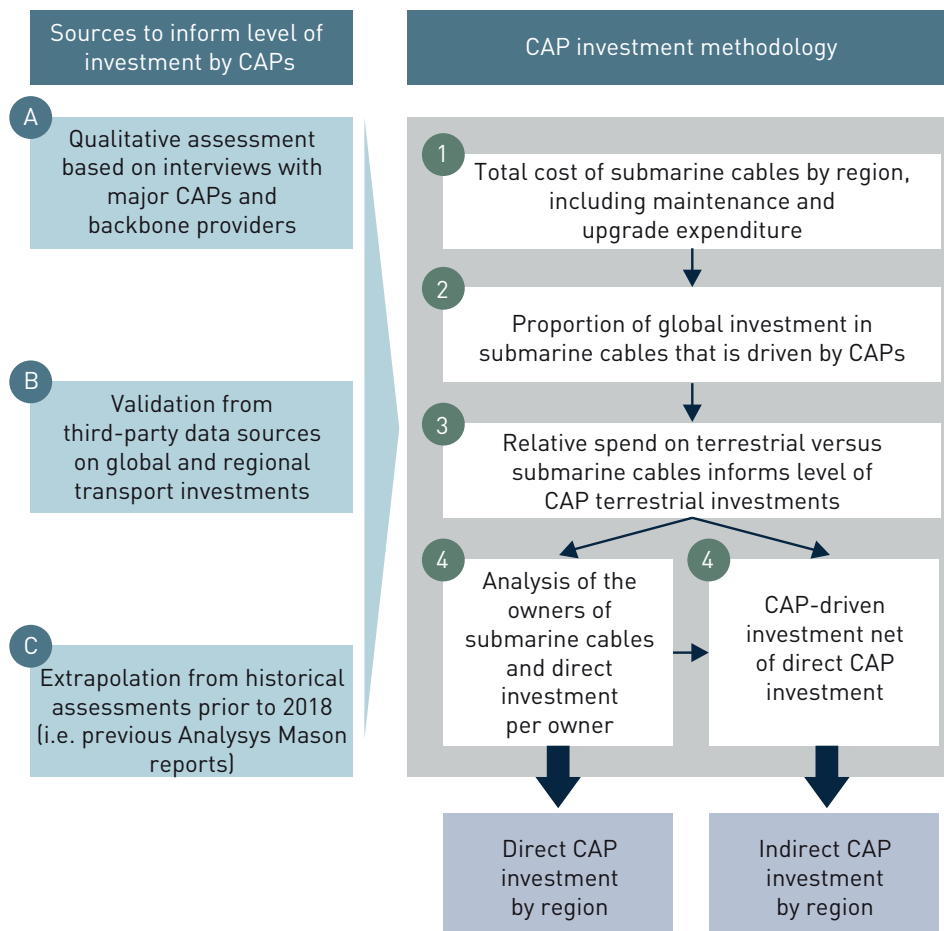

### B.1.3 Delivery

The methodology for estimating the level of investment made by CAPs in delivery infrastructure consists of estimates of the level of investment made in IXPs and private peering locations, as well as the investment in caching.

#### > IXPs and private peering locations

The methodology for estimating the level of investment made by CAPs in IXPs and private peering locations first assesses the total investment made in IXPs by all players; this total level of investment is then adjusted by considering the share that is driven by CAPs (this counts as indirect investment by CAPs). Direct investment comprises costs for installing routers in IXPs, as well as in private peering equipment.

**1. Investment in IXPs.** We estimate the total global investment in IXPs based on reported capex over the relevant period for major IXPs and their associated peak traffic. This is then scaled up to derive global investment based on the peak traffic of all IXPs, based on third-party sources.

**2. Indirect CAP investment in IXPs.** Third-party data is used to estimate the percentage of IP addresses which are used by CAPs, which is then used to calculate indirect CAP investment in IXPs.

**3. Direct CAP investment in IXPs.** Direct CAP investment is estimated based on two components, first the investment into private peering locations and second the investment into routers and ports:

a. Investment into private peering is estimated using third-party sources for the ratio of private to public peering locations for major CAPs and considers the volume of traffic that passes through private versus public peering locations. By assuming these ratios are representative of the entire market, we apply them to the total CAP indirect investment in IXPs to estimate direct investment by CAPs into private peering.

b. Investment by CAPs into routers and ports is estimated based on the number of IXP members that are CAPs (based on third-party data) and multiplied by the average cost per connection sourced from benchmark data and validated through interviews with major CAPs and IXPs.

**FIGURE B.3:** MODELING TO ASSESS THE INVESTMENT MADE BY CAPs IN PEERING INFRASTRUCTURE  
[SOURCE: ANALYSYS MASON, 2022]

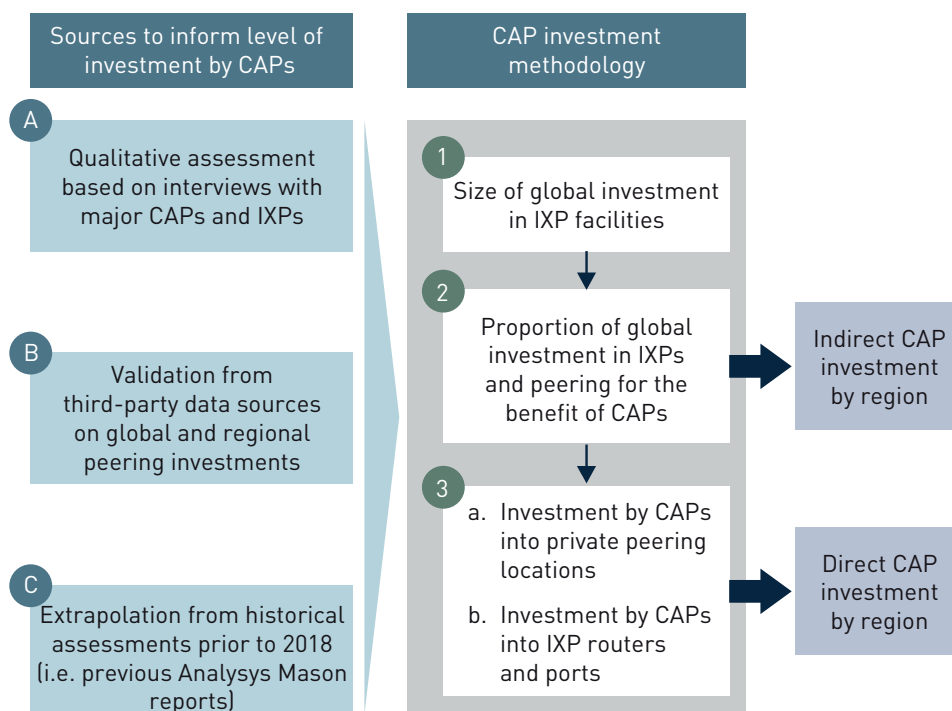



> CDNs

The level of investment made by CAPs in CDNs is estimated in two steps: first, global indirect (i.e. commercial) CDN investment is calculated, and then the subsequent direct CAP capex (i.e. private CDNs) is calculated.

**1. Indirect CDN investment.** Our analysis is based on the financial reports of major commercial CDN providers. The ratio of CDN capex to revenue is calculated for major CDN providers, and this is then applied to estimates of total commercial CDN market revenue, based on third-party sources, to estimate global indirect CAP investment in CDNs. The regional split of investments is derived from interviews with major CAPs and CDN providers, and third-party data on regional market shares.

**2. Direct CDN investment.** The level of direct investment is estimated from the ratio of private (internal) versus commercial (external) CDN usage based on expert interviews and third-party data sources. It is validated based on extrapolation from historical assessments made by Analysys Mason prior to 2018, which is then used as a proxy of the proportion of direct and indirect investment in CDNs.

**FIGURE B.4:** MODELING TO ASSESS THE INVESTMENT MADE BY CAPs IN CDNs  
[SOURCE: ANALYSYS MASON, 2022]

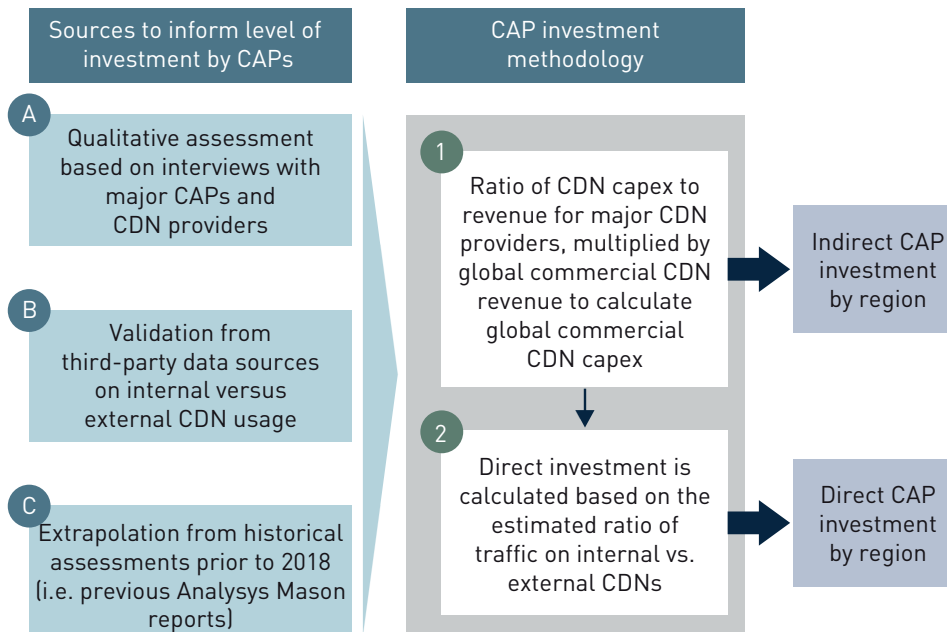

## B.2 Examples of how internet infrastructure investment is evolving

In the main body of the report, Section 2.2 provides an overview of the key clusters of investment in internet infrastructure that CAPs make (namely the hosting, transport, and delivery clusters), describes some of the key trends that are driving continued investment in each cluster, and quantifies the investment made by CAPs from 2018 to 2021, which was higher than in previous periods. Beyond the increasing amount of spending, it is also worth noting that CAPs, as well as other key entities in the internet infrastructure value chain, continue to innovate at different parts of the chain.

This sub-section provides a few examples of innovations by CAPs and other entities in the three main clusters of investment considered. It also explores other areas beyond these three main clusters that CAPs are making contributions to, and how contributions to these other areas also improve connectivity across the globe.

### B.2.1 Hosting

CAPs rely heavily on hyperscale data centers, which house computing power for a variety of applications and services. These hyperscale facilities are always of a much larger scale than traditional data centers, are more power and cost efficient, and typically offer greater reliability.

Often, CAPs would self-build hyperscale data centers in locations with specific advantages – for instance, data centers in cooler climates benefit from lower cooling costs, while a reliable supply of renewable electricity, ideally available at low cost, supports better economics and sustainability goals.

CAPs also tend to employ innovative new technologies in their hyperscale data centers that improve performance and cost, as well as energy efficiency. For example, large CAPs in the US tend to adopt green power for a major share of their annual electricity usage.<sup>148</sup> Several examples of more recent innovations in data centers that contribute to sustainability objectives are described in the case study below.

#### Case study: CAPs are introducing innovative data-center technology to reduce their carbon footprint and costs

Data centers consume large amounts of power to both run and cool IT equipment. In the context of initiatives ranging from utilizing green power to replacing conventional lighting, the most prominent requirement is the need for systems to cool the equipment, which use up to 40% of the data center's energy.<sup>149</sup> Recent new developments in cooling include direct-to-chip liquid cooling and immersion cooling, which increase efficiency, reduce costs, and save energy compared to traditional air cooling.

Meta and Google introduced liquid cooling in 2018, which works by using water instead of air to cool IT equipment.<sup>150</sup> The global liquid cooling market is expected to grow from USD1.2 billion in 2022 to USD6.4 billion in 2027.<sup>151</sup> In 2021, Microsoft began using liquid immersion in one of its data centers in North America.<sup>152</sup> This involves immersing IT equipment in a non-conductive liquid that can capture up to 100% of the server heat, as opposed to air cooling, which only captures 30% of the server heat. Research indicates this will help to reduce the carbon footprint of the data center by up to 30%.<sup>153</sup>

<sup>148</sup> United States Environmental Protection Agency (2022), *Green Power Partnership Top 30 Tech & Telecom*. Available at <https://www.epa.gov/greenpower/green-power-partnership-top-30-tech-telecom>

<sup>149</sup> GRC (2022), *Liquid Immersion Cooling Reduces Power Use and Drives Sustainability Efforts in Data Centers*. Available at <https://www.grcooling.com/wp-content/uploads/2022/04/grc-liquid-immersion-cooling-reduces-power-use-and-drives-sustainability.pdf>

<sup>150</sup> Datacenterknowledge (2018), *Facebook's New Data Center Cooling Design Means It Can Build in More Places*. Available at <https://www.datacenterknowledge.com/facebook/facebook-s-new-data-center-cooling-design-means-it-can-build-more-places>

<sup>151</sup> Globalnewswire (2022), *The Worldwide Data Center Liquid Cooling Industry is Expected to Reach \$6.4 Billion by 2027*. Available at <https://www.globenewswire.com/news-release/2022/07/01/2472719/28124/en/The-Worldwide-Data-Center-Liquid-Cooling-Industry-is-Expected-to-Reach-6-4-Billion-by-2027.html>

<sup>152</sup> Microsoft (2021), *To cool datacenter servers, Microsoft turns to boiling liquid*. Available at <https://news.microsoft.com/innovation-stories/datacenter-liquid-cooling/>

<sup>153</sup> Green Revolution Cooling (2021), *How Liquid Immersion Cooling Benefits Sustainability*. Available at <https://www.grcooling.com/blog/how-liquid-immersion-cooling-benefits-sustainability/>

## B.2.2 Transport

In the context of long-distance transport networks, CAP investment in submarine cables has generally been more widely publicized than investment in terrestrial capacity. CAPs account for a large share of investment in new submarine cables deployed between 2018 and 2021, particularly cables between Asia, Europe, and North America.

In addition, many CAP investments in submarine cables are driven by the requirement for more geographically unique routes. In Latin America, the Google-owned Curie submarine cable was the first new submarine cable to connect to Chile in 19 years, for example.<sup>154</sup> In Africa, both Meta and Google have announced significant projects to improve international connectivity for the continent. Meta's 2Africa, owned by a consortium of eight global partners, is the largest cable project in the world, boasting a length of 45 000km from Europe to Africa and Asia.<sup>155</sup> Meanwhile, Google's fully self-funded Equiano cable connects Europe to the west coast of Africa,<sup>156</sup> and would further improve connectivity for the latter region.

At least four main CAPs (Google, Meta, Amazon, Microsoft) are directly investing as part of consortia with other carriers. Google and Meta have also invested as anchor investors in some cables. For example, Google's Grace Hopper submarine cable was announced in 2020 and connects North America with Europe.<sup>157</sup> There are also examples of smaller consortia where CAPs are taking on a larger share of investment. For example, Meta's 80% ownership of the trans-Atlantic Amitié cable is expected to be completed in 2022.<sup>158</sup> CAPs also provide capacity to third parties on cables where CAPs are the majority owners. Since 2021, Lumen has utilized the Google-owned trans-Atlantic Dunant submarine cable,<sup>159</sup> and in 2018, Telxius acquired fiber pairs on the Google-owned Junior cable in Latin America.<sup>160</sup>

By investing more directly in submarine cables, CAPs achieve greater control of costs, network design, and ongoing performance. A few of the innovations that CAPs have made in their submarine cable deployments are described in the case study below.

### Case study: CAPs deploy submarine cable systems that are technologically advanced

While traditional submarine cable systems were often deployed with 4 to 8 fiber pairs,<sup>161</sup> many cable systems recently deployed by CAPs have 12 or more fiber pairs.<sup>162</sup> In October 2021, it was announced that Meta had commissioned NEC to deploy a new transatlantic cable with 24 fiber pairs, with 200 times the capacity of transatlantic cables built 20 years earlier.<sup>163</sup>

Apart from deploying more capacity than on older cables, new cables deployed by CAPs also have other new innovative features. For example, the Grace Hopper cable deployed by Google featured a new fiber-optic switching system that was developed with SubCom and results in increased reliability by enabling an easier flow of traffic around outages.<sup>164</sup> The 2Africa system deployed by Meta features a new aluminum conductor system that replaces traditional copper conductors; Meta is also exploring ways to power long cables more effectively.<sup>165</sup>

<sup>154</sup> Google Cloud (2019), *Curie subsea cable set to transmit to Chile, with a pit stop to Panama*. Available at <https://cloud.google.com/blog/products/infrastructure/curie-subsea-cable-set-to-transmit-to-chile-with-a-pit-stop-to-panama>

<sup>155</sup> *Engineering at Meta (2021), 2Africa Pearls subsea cable connects Africa, Europe and Asia to bring affordable, high-speed internet to 3 billion people*. Available at <https://engineering.fb.com/2021/09/28/connectivity/2africa-pearls/>

<sup>156</sup> Google Cloud (2019), *Introducing Equiano, a subsea cable from Portugal to South Africa*. Available at <https://cloud.google.com/blog/products/infrastructure/introducing-equiano-a-subsea-cable-from-portugal-to-south-africa>

<sup>157</sup> Google Cloud (2020), *Announcing the Grace Hopper subsea cable, linking the U.S., U.K. and Spain*. Available at <https://cloud.google.com/blog/products/infrastructure/announcing-googles-grace-hopper-subsea-cable-system>

<sup>158</sup> Submarine Cable Networks (2022), *Amitié/AEC-3*. Available at <https://www.submarinenetworks.com/en/systems/trans-atlantic/amitie>

<sup>159</sup> Lumen (2021), *The push for international bandwidth grows*. Available at <https://news.lumen.com/2021-07-29-Lumen-launches-new-on-net-subsea-fiber-route-between-U-S-and-France,1>

<sup>160</sup> Capacitymedia (2021), *New generation subsea infrastructure to make communications in Latam thrive*. Available at <https://www.capacitymedia.com/article/29otd6mddjpestgfijlz4/big-interview/new-generation-subsea-infrastructure-to-make-communications-in-latam-thrive>

<sup>161</sup> Dgtl Infra (2022), *Submarine cables: The invisible fiber link enabling the internet*. Available at <https://dgtlinfra.com/submarine-cables-fiber-link-internet/>

<sup>162</sup> Total Telecom (2022), *Understanding the technologies reshaping the subsea cable market*. Available at <https://www.totaltele.com/513184/Understanding-the-technologies-reshaping-the-subsea-cable-market>

<sup>163</sup> ZDNet (2021), *NEC scores deal to build Facebook transatlantic half-petabit cable*. Available at <https://www.zdnet.com/home-and-office/networking/nec-scores-deal-to-build-facebook-transatlantic-half-petabit-cable/>

<sup>164</sup> Google Cloud (2020), *Announcing the Grace Hopper subsea cable, linking the U.S., U.K., and Spain*. Available at <https://cloud.google.com/blog/products/infrastructure/announcing-googles-grace-hopper-subsea-cable-system>

<sup>165</sup> Tech at Meta (2021), *Inside the Lab: Expanding connectivity by sea, land, and air*. Available at <https://tech.fb.com/engineering/2021/10/inside-the-lab-connectivity/>

### B.2.3 Delivery

Delivery networks continue to evolve to enable content and applications to be delivered more efficiently to end users, while also improving quality of experience. In this part of the internet infrastructure value chain, several other types of entities apart from the main CAPs, such as IXPs, CDNs, as well as ISPs, continue to play an important role in enabling improvements in delivery, and also work collaboratively with larger CAPs to realize ongoing improvements in these networks, both in peering and caching.

For peering, CAPs typically invest directly in private peering (switching and routing equipment connected to ISP networks) and indirectly in public peering (fees paid to IXPs for capacity in the switch and overhead). CAPs use public peering at IXPs to interconnect with many peering partners in the same location. If sufficient volume is reached with a particular partner, then it becomes more cost effective for the CAP to enter into a private peering agreement, sometimes referred to as a private network interconnect (which could take place in the same location as the IXP).

As described in Section 2.2 of the main body of the report, traffic exchanged through private peering is growing more rapidly than traffic exchanged through public peering. Nonetheless, public peering remains important, and IXPs continue to find new ways to contribute to the ecosystem.

Some IXPs are now allowing private peering through their facilities and IT infrastructure, particularly when they have access to multiple data centers. For instance, the London internet Exchange (LINX) provides Private Interconnect (PI) which allows two members to establish a dedicated connection between them.<sup>166</sup> Established IXPs are also expanding into new markets where there is demand for internet exchanges and that have favorable regulatory environments. For example, LINX announced in 2022 that it will establish a new connection facility in Kenya, where it expects cloud computing to become increasingly important.<sup>167</sup>

IXPs are also collaborating with one another to deliver on ongoing improvements, with some examples of these shown in the case study below.

#### Case study: Internet exchanges are collaborating more to improve efficiencies

Since 2021, four of the world's leading internet exchanges, AMS-IX, DE-CIX, LINX, and Netnod, have begun collaborating to help reduce the chances of a single software defect that could create internet-scale problems. By implementing open-source Border Gateway Protocol (BGP) software, more efficient routes for delivering internet traffic will be enabled.<sup>168</sup>

In 2019, collaboration between the same exchanges helped develop a universal application programming interface (IX-API) through an open industry standard, for simpler communication among multiple internet exchanges.<sup>169</sup> This increases productivity and transparency while reducing the configuration time and cost per transaction.

<sup>166</sup> LINX (2022), *Private Interconnection*. Available at <https://www.linx.net/services/private-interconnect/>

<sup>167</sup> LINX (2022), *LINX Announces New Regional Interconnection Hub in East Africa*. Available at <https://www.linx.net/news/linx-announces-new-regional-interconnection-hub-in-east-africa/>

<sup>168</sup> AMS-IX (2021), *Leading global internet exchange operators collaborate to strengthen open source BGP implementations*. Available at <https://www.ams-ix.net/ams/news/leading-global-internet-exchange-operators-collaborate-to-strengthen-open-source-bgp-implementations>

<sup>169</sup> AMS-IX (2019), *AMS-IX, DE-CIX and LINX develop a universal IX-API*. Available at <https://www.ams-ix.net/mum/news/ams-ix-de-cix-and-linx-develop-a-universal-ix-api>

Large CAPs are investing in CDNs for delivery of content, as well as cloud services. Some of these large CAPs have invested in building their own CDNs. However, third-party commercial CDN providers remain relevant in the market, particularly as several

video-streaming providers have opted for multi-CDN solutions. These developments have led to a relatively dynamic content delivery space, and new initiatives such as open caching are emerging, as described in the case study below.

**Case study: Open caching allows ISPs to adopt a standardized approach to developing CDN solutions to improve end-user experience**

Open caching, one of multiple initiatives of the Streaming Video Alliance (SVA), identifies components and basic architectural guidelines needed for a universal caching system that ISPs and content providers could adopt.<sup>170</sup> ISPs would be able

to develop their own CDN solutions, based on open-caching specifications, and could allow content providers also familiar with these specifications to easily cache their content closer to end users by paying for CDN services from the ISP. Some providers have already started trialing this system; for instance, Disney is collaborating with Verizon through its open caching developed based on SVA's specifications to deliver Disney+ content.<sup>171</sup>

#### B.2.4 Other investments

Aside from the internet infrastructure investments made across the three main clusters described above,

CAPs are also making other investments that would help improve connectivity in the future, as described further below.

**Case study: Other examples of initiatives by CAPs aimed at improving future connectivity**

These initiatives can broadly be categorized into access network investments, other initiatives that help to facilitate the expansion of broadband, and initiatives that target improvements in the connectivity supply chain.

Compared to investments in hosting, transport, and delivery, CAPs have more varied approaches to access network investments. These range from more conventional access network deployments, such as FTTH builds by Google Fiber,<sup>172</sup> to more adventurous initiatives such as Meta's Terragraph, which uses street-level radios and unlicensed spectrum in the 60GHz bands,<sup>173</sup> as well as

Amazon's foray into low Earth orbit (LEO) satellite as part of Project Kuiper.<sup>174</sup>

CAPs have also developed initiatives that can help to expand the availability of broadband in future, but that do not involve building access networks directly. Examples of these include Meta's investments in long-haul and metro fiber networks in partnership with Liquid Intelligent Technologies in the Democratic Republic of the Congo,<sup>175</sup> as well as more experimental initiatives such as the Taara project that Google is developing under the X Development LLC entity. Taara aims to use beams of light traveling through the air to establish high-throughput wireless backhaul links to remote areas.<sup>176</sup>

<sup>170</sup> Streaming Video Alliance. Available at <https://www.streamingvideoalliance.org/>

<sup>171</sup> Fierce Video (2022), Verizon, *Disney begin Fios open caching trial for Disney+ streamers*. Available at <https://www.fiercevideo.com/tech/verizon-disney-begin-fios-open-caching-trial-for-disney-streamers>

<sup>172</sup> Google Fiber (2022), *Next up: The Grand Canyon State*. Available at <https://fiber.google.com/blog/2022/07/next-up-grand-canyon-state.html>

<sup>173</sup> Meta Connectivity Terragraph. Available at <https://www.facebook.com/connectivity/solutions/terragraph>

<sup>174</sup> Amazon (2021), *Project Kuiper announces plans and launch provider for prototype satellites*. Available at <https://www.aboutamazon.com/news/innovation-at-amazon/project-kuiper-announces-plans-and-launch-provider-for-prototype-satellites>

<sup>175</sup> Capacity Media (2021), *Liquid partners Facebook on fibre network in the DRC*. Available at <https://www.capacitymedia.com/article/29otdc38gbc2vnjhyhyps/news/liquid-partners-facebook-on-fibre-network-in-the-drc>

<sup>176</sup> X – The Moonshot Factory. *Taara: Expanding fast and affordable global internet access with beams of light*. Available at <https://x.company/projects/taara/>

Lastly, CAPs have also contributed to initiatives that have generated benefits for various stakeholders across the internet and connectivity supply chains. The Open Compute Project was launched in 2011 to enable open-source collaboration with regard to data-center designs and best practices, and counts CAPs such as Alibaba, Baidu, ByteDance, Google, Meta, and Microsoft as members.<sup>177</sup> Another key example of such an initiative is the more recently launched Telecom Infra Project that was introduced by Meta (then Facebook) in 2016,<sup>178</sup> and that brings together various stakeholders,<sup>179</sup> including telecom operators, hardware and software vendors, systems integrators, as well as government agencies to develop, test, and deploy open and disaggregated solutions. The collaboration between stakeholders, facilitated by the Telecom Infra Project and others, has the potential to improve supply chain diversity for telecom networks, and produce more performant, flexible, resilient, and cost-efficient networks in the long term.<sup>180</sup>

<sup>177</sup> Open Compute Project. *Membership Directory*. Available at <https://www.opencompute.org/membership/membership-organizational-directory>

<sup>178</sup> Meta (2016), *Introducing the Telecom Infra Project*. Available at <https://about.fb.com/news/2016/02/introducing-the-telecom-infra-project/>

<sup>179</sup> Telecom Infra Project. *Who we are*. Available at <https://telecominfraproject.com/who-we-are/>

<sup>180</sup> Analysys Mason (2021), *The economic impact of open and disaggregated technologies and the role of TIP*. Available at <https://www.analysismason.com/consulting-redirect/reports/impact-of-open-and-disaggregated-technologies-and-tip/>

## Annex C Context on the impact of traffic on fixed and mobile network costs and methodology for estimating traffic-sensitive costs for fixed networks

### C.1 Factors affecting the sensitivity of network costs to traffic

Since 2018, global traffic delivered over fixed and mobile access networks has increased significantly; over this same period, network-related annual spend by telecom operators has remained relatively stable, as shown in Section 3.2 of the report. In this first subsection of Annex C, evidence is presented to demonstrate how and why network costs in fixed and mobile networks have not scaled proportionally with traffic, and are unlikely to do so in future.

#### C.1.1 Fixed network costs and factors affecting sensitivity to traffic

In fixed access networks, costs do not scale directly with traffic: the capacity of access links is broadly fixed, and aligned with the speed at which the connection is sold to end users. This means that ISPs have to engineer their access networks to deliver the speed they market and sell to end users, at which point the bandwidth the access link can deliver is predictable and independent of traffic.<sup>181</sup> In the long run, access network deployments are driven by technology shifts, generational upgrades and competition, and as access networks are upgraded, higher speeds for end users are enabled, facilitating greater levels of traffic demanded by end users through the use of more advanced applications.<sup>182</sup>

Many networks today are being re-engineered to offer FTTH (or fiber to the office) rather than rely on copper (or coaxial) cables. This is being done in part because the performance of fiber optics in access networks is generally not sensitive to distance, particularly when compared to legacy copper networks, where

performance degrades materially as distances increase.<sup>183</sup> This property of fiber optics compared to copper allows ISPs to reach their base of end users with fewer nodes than in copper networks, as performance holds up over longer distances. Because of this, many operators are rationalizing the number and location of their network nodes, in particular reducing the number of edge or local nodes to which end-user premises are connected.

Plans announced by ISPs suggest that the number of edge nodes could be reduced substantially, which would reduce network cost as equipment and facilities would be decommissioned and no longer need to be maintained. As a result of this, each remaining edge node would effectively serve a larger number of connections on average. The number of connections that can be served by each edge node can be treated as a measure of efficiency. Networks containing edge nodes capable of serving more connections are considered to be more efficient, resulting in lower costs. These lowered costs can help to counteract any increases in core and backhaul costs that might result from increased traffic.

The extent to which edge nodes are expected to be reduced in various countries is shown overleaf in Figure C.1.

<sup>181</sup> Some access network technologies do include capacity sharing between users, for example cable broadband through DOCSIS technology, and fiber-based first-generation Gigabit passive optical networks (GPONs).

<sup>182</sup> Described further in another report published by Analysys Mason. See <https://www.analysismason.com/consulting-redirect/reports/netflix-open-connect/>

<sup>183</sup> In Europe, BEREC also published a report on a consistent approach to migration in copper switch-off in June 2022, which highlighted that 17 national regulatory authorities had set rules for the migration process and copper switch-off. For details, see [https://www.berec.europa.eu/sites/default/files/files/document\\_register\\_store/2022/6/BoR%20%2822%29%2069\\_BEREC%20Report%20on%20a%20consistent%20approach%20to%20migration%20and%20copper%20switch-off.pdf](https://www.berec.europa.eu/sites/default/files/files/document_register_store/2022/6/BoR%20%2822%29%2069_BEREC%20Report%20on%20a%20consistent%20approach%20to%20migration%20and%20copper%20switch-off.pdf)

**FIGURE C.1:** BENCHMARKS<sup>184</sup> OF EXPECTED REDUCTION IN EDGE NODES THROUGH PROPOSED LOCAL EXCHANGE DECOMMISSIONING PROGRAMS, AND IMPACT ON DENSITY MEASURED IN FIXED BROADBAND CONNECTIONS FOR THE WHOLE MARKET PER EDGE NODE FOR A SINGLE ISP<sup>185</sup>

[SOURCE: ANALYSYS MASON, CONFIDENTIAL BENCHMARKS, REGULATOR REPORTS, PRESS ARTICLES, 2022]<sup>186</sup>

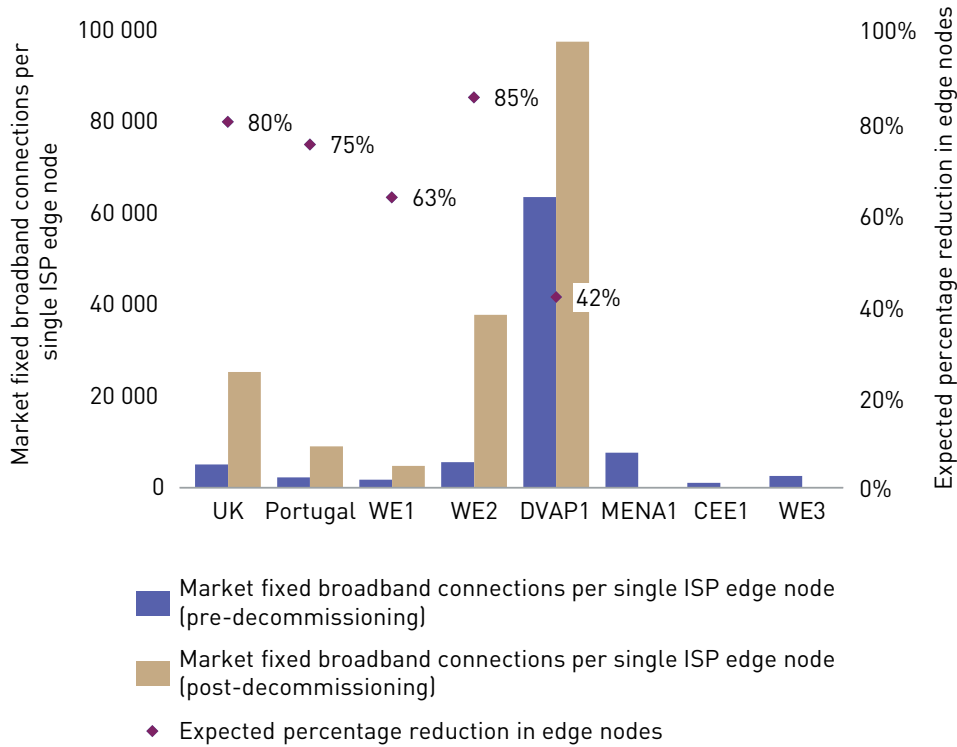

<sup>184</sup> Some benchmarks have been anonymized, and country labels replaced with an indication of the region in which the relevant country is situated – WE refers to Western Europe, DVAP refers to Developed Asia-Pacific, MENA refers to Middle East and North Africa, and CEE refers to Central and Eastern Europe.

<sup>185</sup> Measures total fixed broadband connections in each market, but divides this by the edge nodes of just one single ISP (many of the examples presented refer to fixed incumbent networks).

<sup>186</sup> For UK and Portugal, see ISP Review (2021), *Openreach to Pilot National UK Exchange Closure Plan in 5 Areas*. Available at <https://www.ispreview.co.uk/index.php/2021/11/openreach-to-pilot-national-uk-exchange-closure-plan-in-5-areas.html>; Portugal Telecom (2016), *An All-Fiber Country In An All-Fiber Country*. Available at [https://www.digiworldsummit.com/wp-content/uploads/2016/11/DWS16\\_Luis\\_ALVEIRINHO\\_Portugal\\_Telecom.pdf](https://www.digiworldsummit.com/wp-content/uploads/2016/11/DWS16_Luis_ALVEIRINHO_Portugal_Telecom.pdf)



### C.1.2 Mobile network costs and factors affecting sensitivity to traffic

In mobile markets, and quite unlike fixed markets, operators use data/speed caps to effectively send a price signal to the market, in a way that manages

network usage and associated cost. Even 'unlimited' data offerings that have started to emerge<sup>187</sup> in some more advanced markets tend to have limits placed on speeds after a certain amount of data has been consumed, as shown in Figure C.2.

**FIGURE C.2:** EXAMPLES OF PRICES AND SPEED CAPS FOR VARIOUS UNLIMITED MOBILE DATA PLANS  
[SOURCE: ANALYSYS MASON RESEARCH BASED ON COMPANY WEBSITES,<sup>188</sup> TIM WEBSITE,<sup>189</sup> MTN WEBSITE,<sup>190</sup> 2022]

Region	Country	Provider	Speed cap for unlimited data plan
North America	US	T-Mobile	Speed cap starts after 50GB has been consumed, and the speed cap is only activated during high network congestion
Europe	Germany	O2	Maximum speed of 2Mbit/s for the unlimited data plan
Asia-Pacific	South Korea	KT	Speed cap of 200kbit/s, which starts after 400GB has been consumed
Latin America	Brazil	TIM	Speed cap of 200kbit/s, which starts after 600GB has been consumed
Middle East and Africa	South Africa	MTN	Speed cap of 1Mbit/s, which starts after 200GB has been consumed <sup>191</sup>

Additionally, a significant share of mobile points of presence deployed by operators are deployed to meet coverage requirements. In rural and some suburban areas, the capacity provided by the coverage layer is usually sufficient to meet capacity requirements. It is not unusual for these less traffic-sensitive areas to account for between half and three-quarters of the mobile points of presence in a country.<sup>192</sup> In dense urban and urban areas, operators are more likely to deploy site locations more densely, and also to deploy more capacity on each site. As discussed below, however, mobile networks have evolved to be able to provision additional capacity more efficiently over time.

Mobile operators have continued to receive new spectrum in recent years, and can also refarm spectrum bands currently assigned to older technologies to newer ones. These processes allow operators to add more capacity to their networks. Figure C.3 below provides several examples of new spectrum bands recently assigned by regulators.

<sup>187</sup> Unlimited mobile plans account for a small share of all mobile plans; based on Analysys Mason Research Consumer Survey 2021 data, only 16% of respondents in Europe and the US, 16% of respondents in Asia-Pacific, and 7% of respondents in the Middle East and Africa reported use of an unlimited plan.

<sup>188</sup> Analysys Mason Research (2022), *Mobile handset data pricing benchmark 4Q 2021*. Available at <https://www.analysismason.com/research/content/data-set/mobile-handset-data-pricing-benchmark-rdmm0/>

<sup>189</sup> TIM (2022), *TIM 5G Power Unlimited, Terms of use*. Available at <https://www.tim.it/fisso-e-mobile/mobile/5g-unlimited#hai-bisogno-di-altre-informazioni>

<sup>190</sup> MTN (2022), *Fair Use Policy on the Unlimited data plans*. Available at <https://www.mtn.co.za/Pages/5g.aspx>

<sup>191</sup> The 200GB cap does not include data used between times 12:00am to 5:00am, for which there is another data cap of 200GB. The cap refers to MTN 5G Wi-Fi. In sub-Saharan Africa, mobile is the primary means of accessing the internet, as fixed broadband networks in these countries are less developed.

<sup>192</sup> Based on geoanalysis performed by Analysys Mason during relevant project engagements from 2020–22.

**FIGURE C.3:** EXAMPLES OF RECENT SPECTRUM ASSIGNMENTS

[SOURCE: ANALYSYS MASON, REGULATOR WEBSITES, PRESS ARTICLES, 2022]

Region	Total licensed spectrum assigned as of June 2020 (MHz) <sup>193</sup>			Spectrum band released after June 2020
	Low band	Mid band	High band	
France	640	N/A	1000	<ul style="list-style-type: none"> <li>• 480MHz in 5945–6425MHz in June 2021<sup>194</sup></li> <li>• 110MHz in 3.4–3.8GHz released in October 2020<sup>195</sup></li> <li>• 200MHz in 3.6–3.8GHz released in October 2020<sup>196</sup></li> <li>• 200MHz in 3.8–4.2GHz released in March 2022<sup>197</sup></li> </ul>
Sweden	630	80	N/A	<ul style="list-style-type: none"> <li>• 80MHz in 2300–2380MHz, 100MHz in 3400–3500MHz, 100MHz in 3620–3720MHz, 120MHz in 3500–3620MHz allocated in January 2021<sup>198</sup></li> <li>• 480MHz in 5945–6425MHz and 850MHz in 24.25–25.1GHz released in autumn 2021<sup>199</sup></li> </ul>
US	752	N/A	5550	<ul style="list-style-type: none"> <li>• 100MHz in 3.45GHz allocated in November 2021<sup>200</sup></li> <li>• 200MHz in 3.7–3.9GHz allocated in February 2021<sup>201</sup></li> </ul>
Australia	690	225	N/A	<ul style="list-style-type: none"> <li>• 22MHz in 850MHz auctioned in December 2021<sup>202</sup></li> <li>• 500MHz in 5.925–6.425GHz released in March 2022<sup>203</sup></li> <li>• 3250MHz in 24.25–27.5GHz auctioned in April 2021<sup>204</sup></li> </ul>

<sup>193</sup> Analysys Mason (2020), *Comparisons of Total Mobile Spectrum in Different Markets*. Available at <https://api.ctia.org/wp-content/uploads/2020/06/Comparison-of-Total-Mobile-Spectrum-in-Different-Markets-Final-Report-290620.pdf>

<sup>194</sup> ARCEP (2021), *Décision n° 2021-2184 de l'Autorité de régulation des communications électroniques, des postes et de la distribution de la presse*. Available at [https://www.arcep.fr/uploads/tx\\_gsavis/21-2184.pdf](https://www.arcep.fr/uploads/tx_gsavis/21-2184.pdf)

<sup>195</sup> ARCEP (2022), *5G frequencies: procedure for allocating the 3.4–3.8 GHz band in mainland France*. Available at <https://www.arcep.fr/la-regulation/grands-dossiers-reseaux-mobiles/la-5g/frequences-5g-procedure-dattribution-de-la-bande-34-38-ghz-en-metropole.html>

<sup>196</sup> European 5G Observatory (2021), Available at <https://5gobservatory.eu/national-5g-spectrum-assignment/>

<sup>197</sup> ARCEP (2022), *Consultation publique*. Available at [https://www.arcep.fr/uploads/tx\\_gspublication/consultation-nouvelles-frequences-services-mobiles\\_mai2022.pdf](https://www.arcep.fr/uploads/tx_gspublication/consultation-nouvelles-frequences-services-mobiles_mai2022.pdf)

<sup>198</sup> Swedish Post and Telecom Authority (2022), *3,5 GHz-bandet*. Available at <https://pts.se/sv/bransch/radio/auktioner/3-5-ghz-bandet/>

<sup>199</sup> Swedish Post and Telecom Authority (2022), *Inriktningsplan för spektrumhantering*. Available at <https://pts.se/sv/dokument/pm2/2021/inriktningsplan-for-spektrumhantering/>

<sup>200</sup> Multichannel News (2021), *FCC's Latest 5G (3.45 GHz) Auction Closes, Grosses \$21,888,007,794*. Available at <https://www.nexttv.com/news/fccs-latest-5g-auction-closes-grosses-dollar21888007794>

<sup>201</sup> FCC (2021), *Auction 107: 3.7 GHz Service*. Available at [https://www.fcc.gov/auction/107/factsheet#key\\_dates](https://www.fcc.gov/auction/107/factsheet#key_dates)

<sup>202</sup> ACMA (2021), *850/900 MHz band auction results*. Available at <https://www.acma.gov.au/850900-mhz-band-auction-results-0>

<sup>203</sup> ACMA (2022), *Radio local area networks (RLANs) in the 6 GHz band - consultation 37/2021*. Available at <https://www.acma.gov.au/consultations/2021-10/radio-local-area-networks-rlans-6-ghz-band-consultation-372021#outcome>

<sup>204</sup> ACMA (2021), *26 GHz band auction results*. Available at <https://www.acma.gov.au/26-ghz-band-auction-results>

Ongoing developments in technology allow additional or refarmed spectrum to be added to points of presence more easily at lower cost, due to the introduction of multi-band antennas and network virtualization. Network virtualization enables operators to activate new spectrum frequencies remotely on sites when more capacity is required, as opposed to manually deploying more antennas or swapping out existing antennas with higher-capacity alternatives. Operators also have the ability to anticipate specific locations that would require significant amounts of

capacity and would typically consider pre-emptively deploying significant amounts of capacity upfront using solutions such as massive MIMO antennas and large carriers in the 3.5GHz range.

Spectral efficiency is also expected to continue improving over time, so more data can be carried over a given quantity of spectrum.<sup>205</sup> Antenna upgrades from 4G to 5G increase spectral efficiencies, as shown in Figure C.4 below.

**FIGURE C.4: INCREASE IN APPROXIMATE SPECTRAL EFFICIENCY PER CELL OVER TIME**  
[SOURCE: OFCOM,<sup>206</sup> 2022]

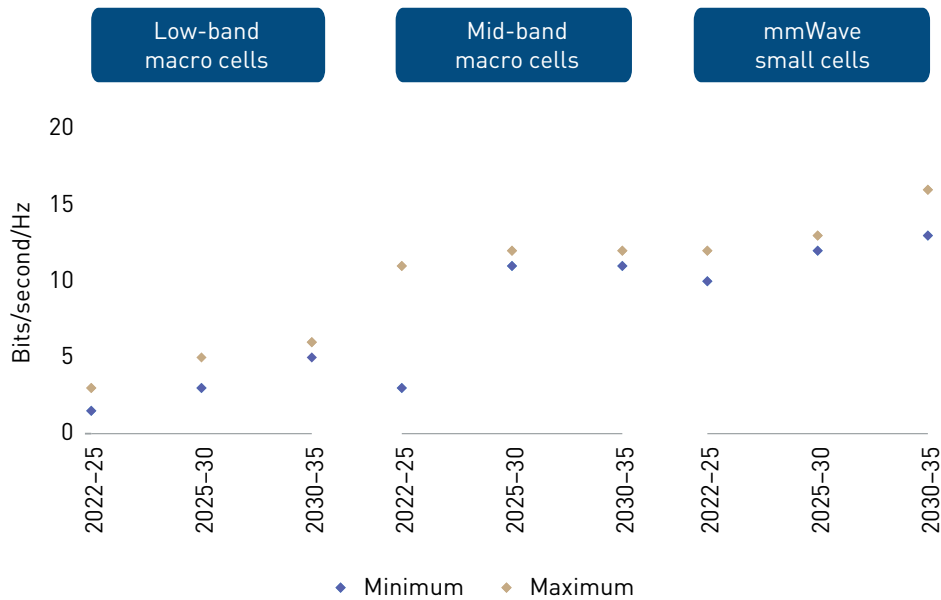

<sup>205</sup> 3GPP [2022], *Specifications*. Available at <https://www.3gpp.org/specifications>

<sup>206</sup> Ofcom [2022], *Mobile networks and spectrum*. Available at [https://www.ofcom.org.uk/\\_\\_data/assets/pdf\\_file/0017/232082/mobile-spectrum-demand-discussion-paper.pdf](https://www.ofcom.org.uk/__data/assets/pdf_file/0017/232082/mobile-spectrum-demand-discussion-paper.pdf)

## C.2 Methodology for estimating fixed ISP network cost savings due to CAP investments

In Section 3.3 of the report, an estimate of traffic-sensitive fixed network costs for ISPs in a baseline scenario is presented. This baseline scenario is intended to represent fixed networks today, i.e. networks that are in a state of transition between legacy and future network architectures. The baseline scenario also accounts for the cost savings that ISPs enjoy as a result of investments made by CAPs in bringing content closer to end users. By making adjustments to assumptions in the baseline scenario, we estimate that costs would be higher if ISPs were not able to benefit from the caching of content closer to end users.

This sub-section of Annex C describes the methodology used to estimate traffic-sensitive core and backhaul fixed network costs in more detail. It also examines the assumptions used regarding the extent to which caching is currently done in fixed networks across regions, in order to arrive at the estimate of savings for ISPs that is achieved.

The developed model calculates core and backhaul costs for a number of representative fixed ISPs. The total sum of these costs, when added up across the number of representative fixed ISPs in a region, reflect the costs associated with actual subscribers in each region. The model also reflects a mix of representative ISPs with less efficient legacy copper-based architectures as well as representative ISPs with more efficient futureproof fiber-based architectures in the baseline scenario.

For each representative ISP network, core and backhaul costs are calculated as a result of the number of users on the network, the bandwidth/traffic requirements of each user, as well as unit costs of various link and node cost components in the network. Link and node cost components are dependent on traffic to an extent, but typically do not scale proportionally. For cost items, both annual cost components, as well as annualized values of one-off cost components, are included in the total cost calculation.

Region-specific figures are used for several key inputs, including the number of users in each region, bandwidth requirements per user, and the estimated extent to which caching of content is used in fixed networks. Estimates for link and IP transit cost inputs also reflect regional differences. Meanwhile, other inputs, such as the split of traffic into video-streaming and non-video-streaming traffic,<sup>207</sup> are applied similarly across regions.

Calculations are made for a number of representative networks in each region, based on different regional inputs, and these are added up to generate an estimate of total core and backhaul costs in fixed networks for regions considered.<sup>208</sup> The methodology described above is illustrated using a flowchart in Figure C.5 below.

<sup>207</sup> Based on historical figures published by Sandvine in its *Global Internet Phenomena Report*, and extrapolated into future periods by Analysys Mason. Original report by Sandvine is available at [https://www.sandvine.com/hubfs/Sandvine\\_Redesign\\_2019/Downloads/2022/Phenomena%20Reports/GIPR%202022/Sandvine%20GIPR%20January%202022.pdf?hsCtaTracking=18fff708-438e-4e16-809d-34c3c89f4957%7C067d9d28-ef90-4645-9d46-c70d10279247](https://www.sandvine.com/hubfs/Sandvine_Redesign_2019/Downloads/2022/Phenomena%20Reports/GIPR%202022/Sandvine%20GIPR%20January%202022.pdf?hsCtaTracking=18fff708-438e-4e16-809d-34c3c89f4957%7C067d9d28-ef90-4645-9d46-c70d10279247)

<sup>208</sup> China has been excluded as content delivery there is relatively insular – some global CAPs deliver no traffic within China and many China-based CAPs deliver relatively little traffic outside China.

**FIGURE C.5:** METHODOLOGY USED TO ESTIMATE CORE AND BACKHAUL COSTS

[SOURCE: ANALYSYS MASON, 2022]

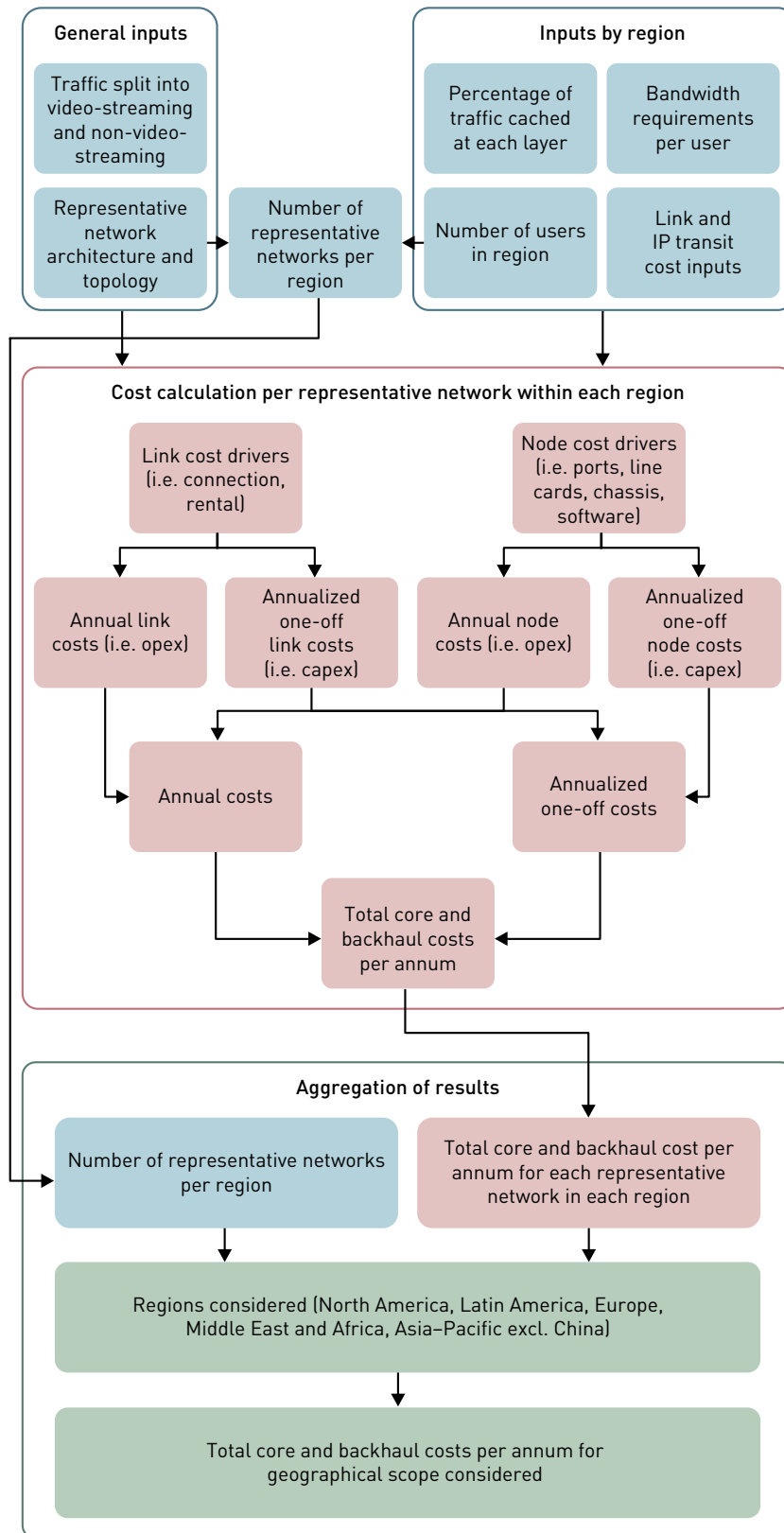

In the baseline case, core and backhaul costs for fixed networks in the regions modeled reach an estimated USD34 billion in 2022, which represents 10% of estimated fixed retail revenue for these regions in the same period. As a share of total network costs, which are typically ~50% of revenue, the traffic-sensitive core and backhaul segment accounts for just ~20%.

A summary of assumptions used to contextualize the baseline core and backhaul network cost estimates generated by the model in the baseline case are presented in Figure C.6 below.

**FIGURE C.6:** ASSUMPTIONS USED FOR CONTEXTUALIZING MODELED CORE AND BACKHAUL NETWORK COSTS  
[SOURCE: ANALYSYS MASON, 2022]

Item	Modeled share of revenue and rationale	
Total network costs	50%	<ul style="list-style-type: none"> <li>Based on an EBITDA margin of 30%, and network opex accounting for 50% of opex, resulting in annual network opex at 35% of revenue</li> <li>Annual network capex equal to 15% of revenue<sup>209</sup></li> </ul>
Core and backhaul network costs	10%	<ul style="list-style-type: none"> <li>As mentioned in Section 3.2 of the report, core and backhaul costs typically account for 10–15% of revenue, meaning that modeled costs are at the bottom end of the benchmark range<sup>210</sup></li> <li>This reflects that some transition from legacy architectures to future architectures has taken place<sup>211</sup></li> <li>Modeled based on inputs and assumptions made by region, for representative networks with 4.5 million connections each at a 30% market share, and scaled up to account for the number of representative networks needed in each region</li> </ul>

Once baseline case cost estimates are generated, assumptions on content caching are then adjusted to reflect a situation where CAP investments are not made, and content is, as a result, not cached closer to end users, resulting in higher costs for ISPs to deliver content.

Our estimates of the impact of embedded caches on the traffic carried by ISPs at different levels of their

networks is shown in Figure C.7 below, and filters through to our baseline cost calculations. For clarity, the figures in the table show that, in Europe, embedded caching reduces video-streaming traffic flows between domestic peering locations (e.g. IXPs) and core nodes by 60%, and reduces video-streaming traffic within the network (flowing between core and metro nodes) by 30%.

<sup>209</sup> A paper published by Axon Partners shows that capital intensity for EU telcos ranged between 15% and 19% from 2014 to 2020, and that this was higher than in other jurisdictions, including the US, Japan, and South Korea. See <https://etno.eu/downloads/reports/europes%20internet%20ecosystem.%20socio-economic%20benefits%20of%20a%20fairer%20balance%20between%20tech%20giants%20and%20telecom%20operators%20by%20axon%20for%20etno.pdf>

<sup>210</sup> Setting these costs at the lower end of the range would suggest a slightly smaller impact of traffic on costs, but would also generate a more conservative estimate of the amount of savings achieved by caching.

<sup>211</sup> In the baseline scenario, half of all modeled connections are served using networks with 20 000 fixed connections in the total market per edge node of just one ISP, and the other half are served using networks with 3000 fixed connections in the total market per edge node of just one ISP.

**FIGURE C.7:** ESTIMATES OF THE PROPORTION OF TRAFFIC SERVED FROM EMBEDDED CACHES IN CORE AND METRO NODES FOR FIXED ISPs IN THE BASELINE SCENARIO

[SOURCE: ANALYSYS MASON, 2022]

	Between domestic IXP and core nodes	Between core nodes and metro nodes
<b>Video-streaming traffic</b>		
North America	30%	15%
Latin America	90%	45%
Europe	60%	30%
Middle East and Africa	90%	45%
Asia-Pacific excl. China	60%	30%
<b>Non-video-streaming traffic</b>		
North America	15%	8%
Latin America	45%	23%
Europe	30%	15%
Middle East and Africa	45%	23%
Asia-Pacific excl. China	30%	15%

With these assumptions set to 0%, the model produces a higher estimate of core and backhaul costs in fixed networks. This higher estimate assumes that embedded caching does not take place, and allows an estimate of ISP savings to be calculated, when compared against the baseline scenario. Given the estimates of how embedded caching results in traffic reductions at various stages shown above, approximate savings for ISPs from embedded caching in 2022 reaches USD5.0 billion.

A similar approach is taken to estimate further savings from bringing content 'on shore' to peering locations. The baseline scenario, as well as the scenario described above with no embedded caching, both assume that IP transit is not necessary as peering takes place at domestic interconnection points. If instead international IP transit is assumed to be needed to replace 10% of traffic currently exchanged through peering at domestic interconnection points, then a further USD1.4 billion of savings can be achieved.<sup>212</sup>

<sup>212</sup> It should be noted that the extent to which IP transit might be needed for international traffic requirements is conservatively set, given that it appears unlikely that IP transit would be able to replace the large amounts of peering currently in place, at comparable (low) prices.

## Annex D Research on FTTP network investment

### D.1 Research to highlight ongoing investment in FTTP networks

As described in Section 4.3.2 of the main body of the report, funding for FTTP deployment is already flowing. Figure D.1 shows forecasts generated by Analysys Mason Research of the amount of capex that is expected to be spent on FTTP in several developed countries between the end of 2020 and the end of 2025,

as well as how FTTP coverage is expected to grow over that period. Countries that have low FTTP coverage at present but have historically relied on other gigabit-capable technologies like cable, are also expected to see significant growth in FTTP coverage in the very near term, in part due to ability to capitalize on those other networks. Examples of these are Germany and Australia, where gigabit-capable coverage was at 67% and 45% in 2020 respectively.

**FIGURE D.1:** FORECAST OF FTTP NETWORK/NON-NETWORK CAPEX AND COVERAGE

[SOURCE: ANALYSYS MASON RESEARCH FTTP COVERAGE AND CAPEX: WORLDWIDE TRENDS AND FORECASTS 2021-27<sup>213</sup>]

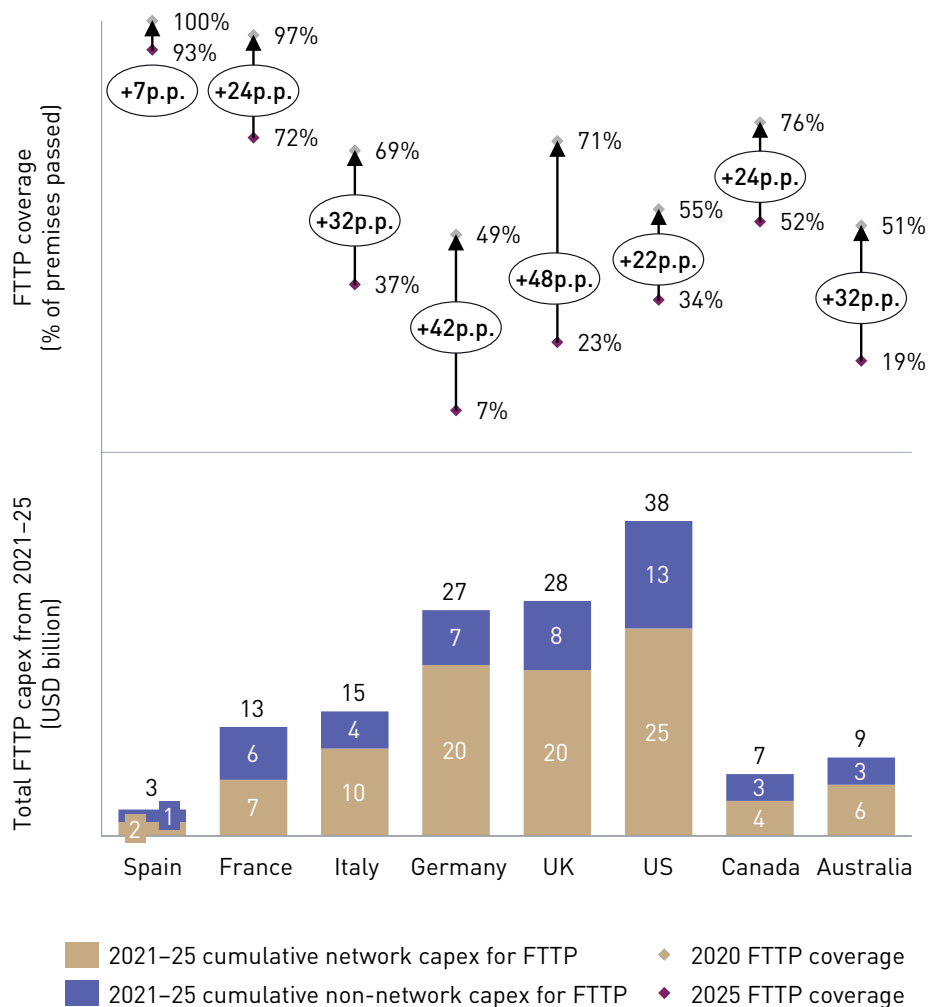

<sup>213</sup> Analysys Mason Research (2022), *FTTx coverage and capex: worldwide trends and forecasts 2021-2027*. Available at <https://www.analysismason.com/research/content/regional-forecasts-fttx-coverage-capex-rdfi0/>



Funding for ongoing investments in FTTP is coming from various sources, including commercial investment by existing operators, greenfield investment (sometimes as public-private partnerships, sometimes by infra funds), and public subsidies (including

Covid-19 recovery funds). Figure D.2 below provides a brief summary of public funding available for broadband deployment in the US and in several major European countries.

**FIGURE D.2: OVERVIEW OF INTERNET AND CONNECTIVITY FUNDING IN THE US AND IN MAJOR EUROPEAN COUNTRIES**  
[SOURCE: EUROPEAN COMMISSION, GOVERNMENT WEBSITES, PRESS ARTICLES, 2022]

Country	Funding program	Details
US	Infrastructure Investment and Jobs Act	<ul style="list-style-type: none"> <li>• USD42.45 billion to the Broadband Equity, Access and Development (BEAD) program for serving underserved and areas currently without broadband</li> <li>• USD14.2 billion to the Affordable Connectivity broadband subsidy program</li> <li>• USD2.75 billion to the Digital Equity program for equipping people with skills</li> <li>• USD2 billion each to the Tribal Broadband Connectivity Program and the Rural Utilities Service Distance Learning, Telemedicine and Broadband Programs</li> <li>• USD1 billion to the Middle Mile grant for connecting major and local networks<sup>214</sup></li> </ul>
	American Rescue Plan	<ul style="list-style-type: none"> <li>• USD10 billion to Capital Projects Fund for affordable internet infrastructure</li> <li>• USD8 billion to state and local governments for assisting households</li> <li>• USD7 billion to FCC's Emergency Connectivity Fund for schools and libraries<sup>215</sup></li> </ul>
	Rural Digital Opportunity Fund	<ul style="list-style-type: none"> <li>• USD20.4 billion to support areas that lack both fixed voice and broadband speeds of at least 25Mbit/s<sup>216</sup></li> </ul>
	U.S. Department of Agriculture	<ul style="list-style-type: none"> <li>• USD401 million to provide high-speed internet for 31 000 rural residents</li> <li>• USD65 billion ReConnect Program for high-speed broadband infrastructure in underserved rural areas and tribal land<sup>217</sup></li> </ul>
	Universal Service Fund	<ul style="list-style-type: none"> <li>• USD100 million to Connected Care Program to cover 85% of the eligible costs of broadband connectivity needed to provide care services to patients<sup>218</sup></li> </ul>

<sup>214</sup> Fierce Telecom (2021), *Broadband gets \$65 billion in U.S. infrastructure bill – here's what happens next*. Available at <https://www.fiercetelecom.com/telecom/broadband-gets-65-billion-u-s-infrastructure-bill-here-s-what-happens-next>

<sup>215</sup> White House Statements and Releases (2022), *FACT SHEET: Biden-Harris Administration Announces Over \$25 Billion in American Rescue Plan Funding to Help Ensure Every American Has Access to High Speed, Affordable internet*. Available at <https://www.whitehouse.gov/briefing-room/statements-releases/2022/06/07/fact-sheet-biden-harris-administration-announces-over-25-billion-in-american-rescue-plan-funding-to-help-ensure-every-american-has-access-to-high-speed-affordable-internet/>

<sup>216</sup> FCC (2020), *FCC Launches \$20 Billion Rural Digital Opportunity Fund*. Available at <https://www.fcc.gov/document/fcc-launches-20-billion-rural-digital-opportunity-fund-0>

<sup>217</sup> USDA (2022), Available at [https://www.rd.usda.gov/newsroom/news-release/biden-harris-administration-announces-401-million-high-speed-internet-access-rural-areas#:~:text=U.S.%20Department%20of%20Agriculture%20\(USDA,investing%20in%20rural%20infrastructure%20and](https://www.rd.usda.gov/newsroom/news-release/biden-harris-administration-announces-401-million-high-speed-internet-access-rural-areas#:~:text=U.S.%20Department%20of%20Agriculture%20(USDA,investing%20in%20rural%20infrastructure%20and)

<sup>218</sup> FCC (2022), *Connected Care Pilot Program*. Available at <https://www.fcc.gov/wireline-competition/telecommunications-access-policy-division/connected-care-pilot-program>

Country	Funding program	Details
US	Consolidated Appropriations Act	<ul style="list-style-type: none"> <li>• USD288 million to Broadband Infrastructure Program</li> <li>• USD980 million to Tribal Broadband Connectivity Program</li> <li>• USD268 million to Connecting Minority Communities Pilot Program<sup>219</sup></li> </ul>
	Appalachian Regional Commission	<ul style="list-style-type: none"> <li>• USD10 million broadband funding for Central Appalachia and USD5 million for North Central and Northern Appalachia</li> </ul>
	Federal Communications Commission	<ul style="list-style-type: none"> <li>• E-rate funding program for schools to obtain affordable broadband, based on demand and with an annual cap of USD4.276 billion<sup>220</sup></li> </ul>
UK	Project Gigabit	<ul style="list-style-type: none"> <li>• GBP5 billion in government funding to enable access to gigabit broadband to at least 85% of households across the UK by 2025 and 100% by 2030<sup>221</sup></li> <li>• GBP210 million voucher scheme to give people in rural areas financial help to get gigabit speeds<sup>222</sup></li> </ul>
France	National Broadband Programme	<ul style="list-style-type: none"> <li>• EUR20 billion in 2013 and an additional EUR280 million in 2020 to achieve nationwide fiber coverage by 2025<sup>223</sup></li> </ul>
	France Relance project	<ul style="list-style-type: none"> <li>• EUR570 million in 2021 to fiber network deployment in rural areas<sup>224</sup></li> </ul>
Germany	Federal funding programme	<ul style="list-style-type: none"> <li>• EUR12 billion to support fiber network expansion and promote fiber networks<sup>225</sup></li> </ul>
Italy	1 Giga	<ul style="list-style-type: none"> <li>• EUR3.65 billion to build broadband services in underserved areas<sup>226</sup></li> </ul>
Spain	Recovery and Resilience Plan	<ul style="list-style-type: none"> <li>• EUR812 million to narrow or close the digital divide between urban and rural areas, of which EUR250 million would be aimed at providing ultrafast fixed broadband networks in rural and remote areas<sup>227</sup></li> </ul>
European Commission	Recovery and Resilience Facility	<ul style="list-style-type: none"> <li>• A fifth of EUR723.8 billion is available to Member States in 2022 to improve digital capabilities including fiber deployment<sup>228</sup></li> </ul>

<sup>219</sup> National Telecommunications and Information Administration. *Grants*. Available at <https://www.ntia.doc.gov/category/grants>

<sup>220</sup> FCC (2022), *E-Rate-Schools & Libraries USF Program*. Available at <https://www.fcc.gov/general/e-rate-schools-libraries-usf-program>

<sup>221</sup> UK Parliament (2022), *Gigabit-broadband in the UK: Government targets and policy*. Available at <https://commonslibrary.parliament.uk/research-briefings/cbp-8392/>

<sup>222</sup> Gov.UK (2022), *Building Digital UK*. Available at <https://www.gov.uk/guidance/building-digital-uk#uk-gigabit-programme>

<sup>223</sup> Simmons & Simmons (2020), *France to invest €240m in funding public fiber networks*. Available at <https://www.simmons-simmons.com/en/publications/ckevg2xubykc70a79erjnxldr/france-to-invest-240m-in-funding-public-fiber-networks>

<sup>224</sup> Comms Update (2021), *French government increases THD funding to EUR3.57bn*. Available at <https://www.commsupdate.com/articles/2021/01/19/french-government-increases-thd-funding-to-eur3-57bn/>

<sup>225</sup> Federal Ministry for Digital and Transport (2021), *Broadband funding by the Federal Government*. Available at <https://www.bmvi.de/SharedDocs/EN/Articles/DG/relaunch-broadband-funding-programme.html>

<sup>226</sup> Telecoms.com (2022), *Italy dangles €3.7 billion in broadband funding*. Available at <https://telecoms.com/512981/italy-dangles-e3-7-billion-in-broadband-funding/>

<sup>227</sup> European Commission (2022), *Broadband in Spain*. Available at <https://digital-strategy.ec.europa.eu/en/policies/broadband-spain>

<sup>228</sup> ING (2022), *Telecom Outlook: Fibre roll-out to reach 60% of European households in 2022*. Available at <https://think.ing.com/articles/fibre-roll-out-to-reach-60-of-european-households-2022/>

**For more details please see:**

<https://www.analysismason.com/internet-content-application-providers-infrastructure-investment-2022>





## Stay connected

You can stay connected by following Analysis Mason via LinkedIn, Twitter and YouTube.

 [linkedin.com/company/analysis-mason](https://www.linkedin.com/company/analysis-mason)

 @AnalysisMason

 [youtube.com/AnalysisMason](https://www.youtube.com/AnalysisMason)

 [analysismason.podbean.com](https://www.analysismason.podbean.com)